

Intelligent Five-Sided Double Column Machining Center

HSA Series Smartcenter

- Hartrol plus controller
- 5-year warranty on guideways
- Spindle run-out : 5 micro
- Gear type 8,000rpm spindle
- Four linear guideways on Z-axis



mode : HSA-X212

Hartrol Plus®
From tradition to intelligent



Facebook



Website

She Hong INDUSTRIAL CO. LTD.

No.3 Jingke N. Road, Taichung City, 408 Taiwan
www.hartford.com.tw Tel: 886-4-23501980 Fax: 886-4-23581793
CAT.No.: 20190705- E14
All Graphic and text on the catalog have been registered. Those who
reprint will be held liable

Hartford

Hartrol · Smartcenter · Robocell

We manufacture intelligent machines only

Imagine what future machines ought to be outlined.

The very first step for fully intelligent machining.

Hartford
redefine the future

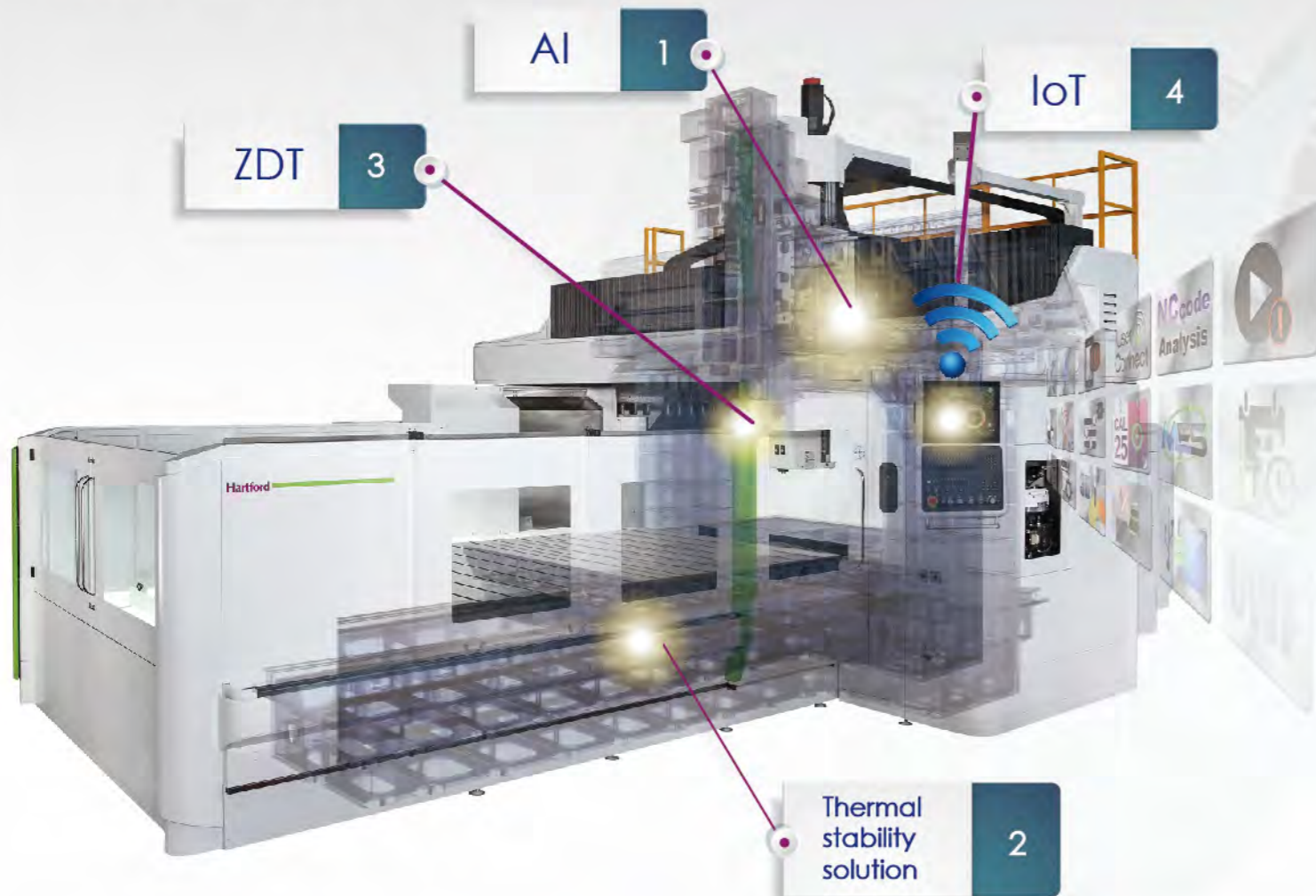

IoT 1

- + Remote Warm-up & Turn-on
- + Hartrol Plus Sync & Update
- + User Connect

Thermal stability solution 2

- + Spindle Thermal Compensation
- + Casting Thermal Compensation
- + Thermal Symmetry / Thermal Balancing

ZDT 3

- + Diagnosis Report on Spindle Operation
- + Alarm Report System

AI 4

- + Facial Recognition System
- + AI Efficient Lubrication Management
- + Smart Efficient Chip Collection

What is Hartrol Plus?

Hartrol plus is a brand new intelligent controller Hartrol , Hartnet and Hartford electrical function together which developed and made by Hartford.

- HMI and operation is user friendly, it can achieve :
1. Internet connection, collect and analyze data, monitoring by portable device
 2. Intelligent control: Auto revise human error and operating basis
 3. Real time update new APPs

The difference between Hartrol plus and others

Function	Hartrol Plus P1	Others
Screen Size	19"Multi-touch Panel	10.4" (OPT:15")
Look Ahead Block	2700(G5P20000)	400(1000 Max.)
Hard Drive	32GB SSD	NO
Smoothing Interpolation	SSS 4G	Option
Industry 4.0	Hartford UserConnect	NO



The Intelligent Controller You Should Have

With three major solutions, Hartrol Plus takes you machining to the next level.

Highly optimized and intelligent controls bring even more capabilities and productivity to your metal cutting processes.

With ease use, advanced automation, and smart data collection, Hartrol plus is essential tool for enhancing performance on your production floor.

Cost down to 20%

- Multi Touch Screen
- CCD remote management
- E-book
- Remote Management
- Cutting Condition Calculator
- Stand-by Mode

Productivity increased 23%

- HartCAM
- AFC= Automatic Feedrate Control.
- SSS-4G
- Machining Time Countdown for Single Block
- Optimized Machining Program
- Automatic measurement

Efficiency increased 20%

- MES(Manufacturing Execution System)
- Machine Utilization Management
- Operator Performance Management
- 24 Hours a Day Management
- Remote Management
- Hartford Userconnect

Hartford UserConnect

- Alert Notification
- Remote Diagnoses
- Remote Value Enhancement
- Remote Monitoring & Management

Hartford APP Store

The main technologies of Hartford smartcenter include intelligent managing system, status monitoring, alarm predicting, machine status diagnosis, crash preventing, 3D program simulation, machining efficiency improving...etc.
All the intelligent functions help you control the machine status and assure the job quality.



Hartford smartcenter APP



The functions mentioned above will need to option the Hartrol plus controller or Dual screen with Fanuc controller.

On line update

With online updating system similar to smart phone will make sure your operating system stays the latest version with Hartford.

- 24hr ➡ Live updating , no boundary no time zone difference.
- NEW ➡ Synchronize with Hartford for the latest information and functions.
- Easy ➡ One key updating, easy and fast !

The Hartrol plus NC version must be A6 or above



On line intelligent remote system.

Integrate 4 major intelligent functions : remote booting warning, controller monitoring, CCD live feeding, auto alarm noticing. Save your time and efficiently increase the connivance of machine operating.

- Increase production efficiency and profit.
- Time saving and better productivity
- Prevent the machine damaging by on time operation monitoring.



What Hartford APP can do for you?

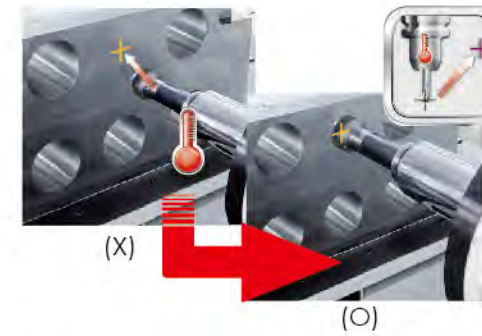

Thermal compensation on spindle(opt.)

No worries about HEAT!!

- Machine with compensation
#40 spindle thermal extension is within 0.03mm
#50 spindle thermal extension is within 0.02mm
 - Machine without compensation
Spindle thermal extension is around 0.10mm
- Notes: Above test is under room temperature



AFC(opt.)

Machining efficiency is increased by 21%↑

- Controls the feed rate depending on the machining situation
- Adjusting feed rate automatically
 - Lengthen your tool life
 - Reduce machining time



Set & Inspect(opt.)

Graphical user interfaces for part setting, inspection, tool setting

- Ease of use
- Increasing usability
- Eliminating manual set-up tasks
- Increasing efficiency



Hartford ZDT

Eliminate machine down time and increase efficiency. ZDT —

1. Ease of use
2. Check parts status clearly
3. Eliminating unexpected down time
4. Instant notification to your machine and your portable device



Spindle Vibration Intelligent Monitoring System (B-Safe) is ensuring spindle stability at times(opt.)

Highlights

1. APP Vibration function is handy to set up manually.
2. Alert status on crash protection.
3. Responsive graphic is available for diagnosis by user, and analytic information is just-in-time served.

Strong cutting force; release your production potential

All New Infinity of high rigidity, high-precision can help you machine blank to become the finished mold of excellent precision and smoothness.



Aerospace component



Hood



Aerospace Part



Table of vertical machining center



Tire

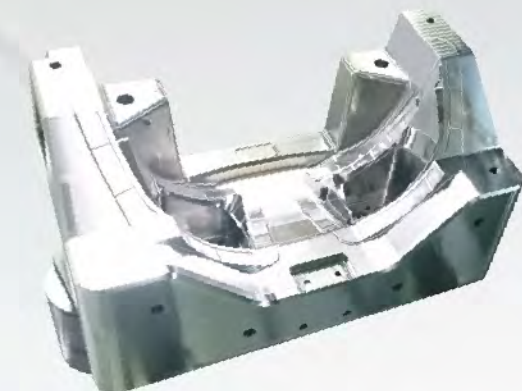

Automobile injection mold



Ship Propeller

Actual Cutting Test

Model: HSA-428

■ Spindle: 6,000 rpm Gear type, 26kW ■ Cutting material : S45C



Face milling

Tool diameter Ø125 mm
 Feed rate 2,050 mm/min
 Cutting depth 4 mm
 Cutting volume 820mm



End milling

Tool diameter Ø63 mm
 Feed rate 1,350mm/min
 Cutting depth 40 mm
 Cutting width 10 mm



Tapping

Tool diameter Ø36 mm
 Feed rate 480 mm/min
 Cutting depth 40 mm
 Spindle load 35%



Drilling

Tool diameter Ø53 mm
 Feed rate 100mm/min
 Cutting depth 50 mm
 Spindle load 50%

All the test results featured in this catalogue were produced under strict testing condition in a special zed testing environment. Under different testing conditions and in less than ideal testing environments, that the test results may vary from those shown in this catalogue.

ALL NEW INFINITY, from roughing to finishing, allows you to accomplish at one go

The new HSA series gives you optimal processing performance and extreme precision performance, while increasing HSA architecture to pair up with homemade automatic switching head mechanism, reaching five-face machining models to meet a variety of your processing needs.



Z-axis four linear guideways three binding structure patented technology

The patented HSA four linear guideways three binding structure technology, two-way support provides high rigidity while cutting, bringing you excellent performance.

Patent No.1264343 machining center Z-axis head Z-axis four linear guideways.



HSA three-axis direct-connected drive advantage

HSA series X-axis and Y-axis pair up with the planetary reducer, effectively enhancing the overall axial drive torque of the machine.

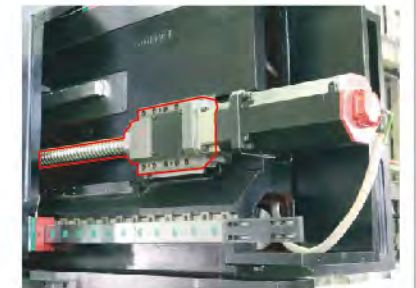

X-axis three linear guideways design HSA-X28/HSA-X32/HSA-X36

The X-axis three linear guideways design can be used to resist process rotation torsion and enhance rigidity by more than 50%. Moreover, the maximum load of a workbench can be 30,000kg, thus allowing you to meet your processing needs and help you each your accuracy and quality requirements.
(HSA-X23/X27/X212 are two linear guideways.)



Full range of linear guideway five-year warranty

Warranty coverage will not apply under following conditions

- 1.Improper operation(collission)
- 2.Lack of regular cleaningof accumulated debris causing damage to the linear rails &carriages.

Unique Machine Structure Design

Screw support mechanism maintains excellent positioning accuracy

- In time of the transmission of the X and Y axes, ensure that power is maintained.
- Improve screw dead weight sagging; enhance the positioning accuracy and life of screw.
- Increase 1 level of screw specification ; lift static rigidity

Model above the 5 meters X-axis is standard configuration; below 4 meters is optional configuration.

Y-axis support mechanism, X36/ EAY is standard configuration.

Y-axis support mechanism, X23/X27/X28/EA is optional configuration.

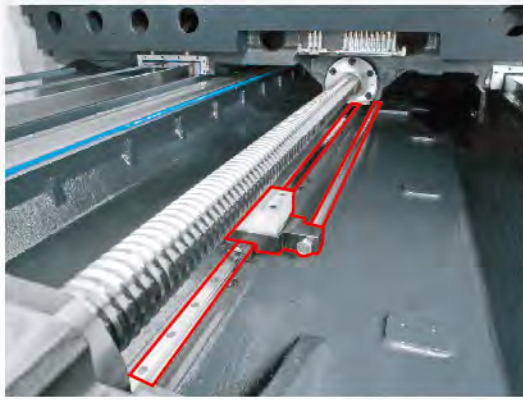

X-axis screw support mechanism

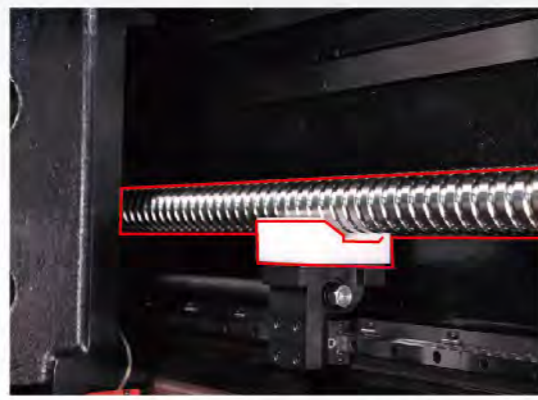

Y-axis screw support mechanism

Diversified strong spindle meets your processing needs

Hartford made gear type 8,000 rpm Two-stage spindle (optional feature)

- To follow the process attribute, pair up with high or low gear.
- Spindle-mounted structure design
- Thermal separation technology enables thermal extension to control and apply to HSA- X23/X27/X28/X32/X36

Hartford made i-Tech hybrid type 10,000 rpm spindle (optional feature)

- Motor and spindle dual cooling circulation design.
- Cooling cycle design
- Built-in motor-maximum **35kw, 600N-m**
Applicable models: EA / EAY



▲ Hartford made i-Tech hybrid type 10,000 rpm spindle (optional feature)



◀ Hartford made gear type 8,000 rpm Two-stage spindle (optional feature)

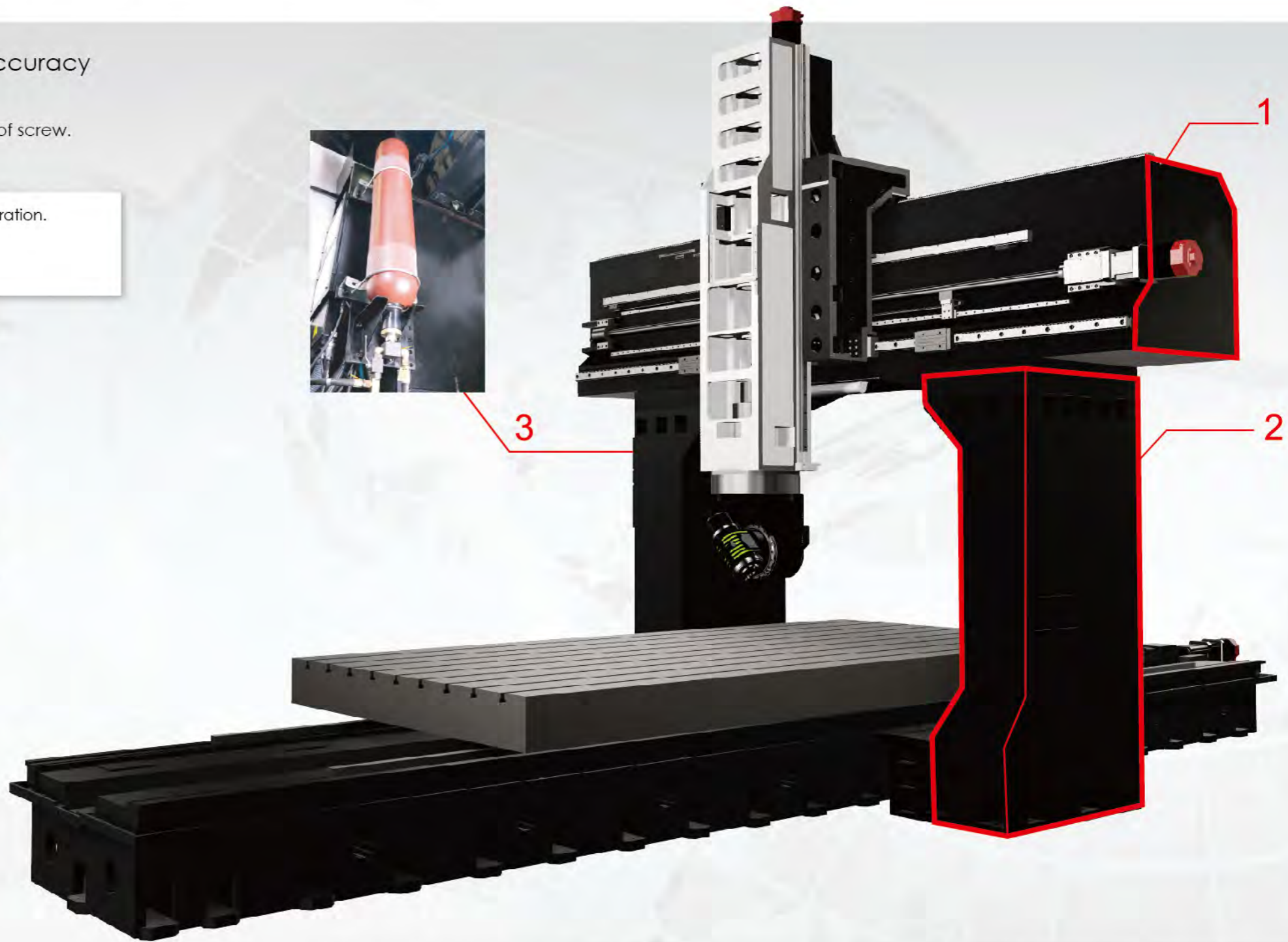

1. The new slant beam design effectively reduces vibration from cutting

- Reduce the vibration generated by the process.
- Enhance accuracy and surface sheet cleanliness during processing.

Patent :
M435318 Beam rear slant design

2. Extra-large columns effectively transfer the maximum cutting force

- The joint width between bottom of the column and the base is increased to 1,250mm
- Reduce overall vibration from cutting.

Patent:
M437316 Structure section has design to resist torsion.
M438938 Column foot span design

3. Z-axis nitrogen accumulator weight system

- Reduce operating noise of hydraulic tank.
- Reduce hydraulic tank oil temperature by 50%
- Effective energy-saving more than 20%
Suitable for HSA-X23/X27/X28/X32/X36 and EA/EAY full range of models.

Complete angular head design package

Hartford has a full range of angular head specifications, in addition to automatic universal heads, automatic 90 degrees head, automatically extension head, automatic grab head to pair up with a 90-degree head, there are series of manual and semi-automatic universal heads, 90 designs head and extension head, etc., for you wide range of processing needs.

Automatic heads(automatic clamp) suitable for HSA-EA/EAY series models.

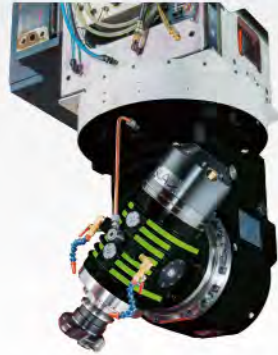

Automatic universal head(2.5°/1°)	Axis	A/C axis division angle configuration table			
A/C axis automatic rotation angle Maximum speed:4,000rpm Maximum power :26 kw The maximum torque to withstand : 930N-m Optional configuration of maximum pressure 70 BAR CTS	C-axis	1°	2.5°	2.5°	1°
	A-axis	1°	2.5°	1°	2.5°
	Remark	ST. standard feature	OPT. customized specifications		



Automatic 90° head(2.5°/1°)
 Maximum speed:4,000 rpm/2,500(opt.)
 Maximum power :26kw
 The maximum torque to withstand : 930N-m
 Optional configuration maximum pressure 70 BAR CTS
 Minimum optional configuration C-axis positioning indexing :1 degree



Automatically extension head (350/500mm)
 Maximum speed:4,000 rpm
 Maximum power :25kw
 The maximum torque to withstand : 750N-m
 Optional configuration of maximum pressure 70 BAR CTS
 Automatic tool change function



Auto clamp/unclamp + the manual 90° head
 Maximum speed:2,000 rpm
 Maximum power :18.5kw
 The maximum torque to withstand : 650N-m
 External guide pins enhance the positioning accuracy of the exchange head, with automatic grab head function and manual rotating angle function.

Angular head exclusive technology

Patented technology

Patented technology



Clutch-type vertical skew angular axis head. The clutch lock of the horizontal axis(CHE)
 During clutch, the electromagnetic brake will activate on both the rotating and linkage shaft. The slanting swing is generated by gravity. Reduce the amount of slanting swing while in clutch to avoid tooth jamming.



Angular head C-axis 1 degree positioning mechanism (TWC)
 Angular head C-axis 1-degree indexing positioning function. Because the whole transmission system is a fully closed loop, it can still better eliminate the origin of mechanical backlash.



Angular head center coolant mechanism (UAC)
 All automatic head classes have CTS function, can give customers maximum tool life and processing performance.

Intelligent technology



Minimum optional configuration A/C-axis positioning indexing : 1 degree
 In AC travel, arbitrary integer angular inclined surface processing needs. (Optional accessory)

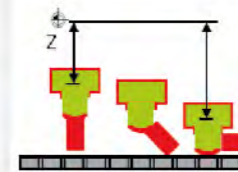

Auto angular head travel intelligent switching
 Solves the problems of switching between travel and protected areas so that the travel limit (Y-axis & Z-axis) is automatically adjusted according to the universal head angular. (Standard accessory)



AC universal head rotation center + Tool tip automatic error measurement function
 Raises processing accuracy, reduces manual measurement error, and shortens the measurement time. In time of measured comprising a heat deflection of the angle head, so it is possible to improve accuracy errors. (Optional accessory)

Adhere to quality and meticulous detail

Hartford adheres to each gradation, grasps every possibility, and is devoted to adhering to quality and meticulous detail.

By demanding quality precision within each process, we remain dedicated to producing the best.



• Check gear



• End surface flatness correction

• Adjust teeth clearance

Automatic angular head switching head compartment

EA/EAY series can be combined with automated switching head compartment and vertical and horizontal tool change system, to provide highly efficient versatile processing.

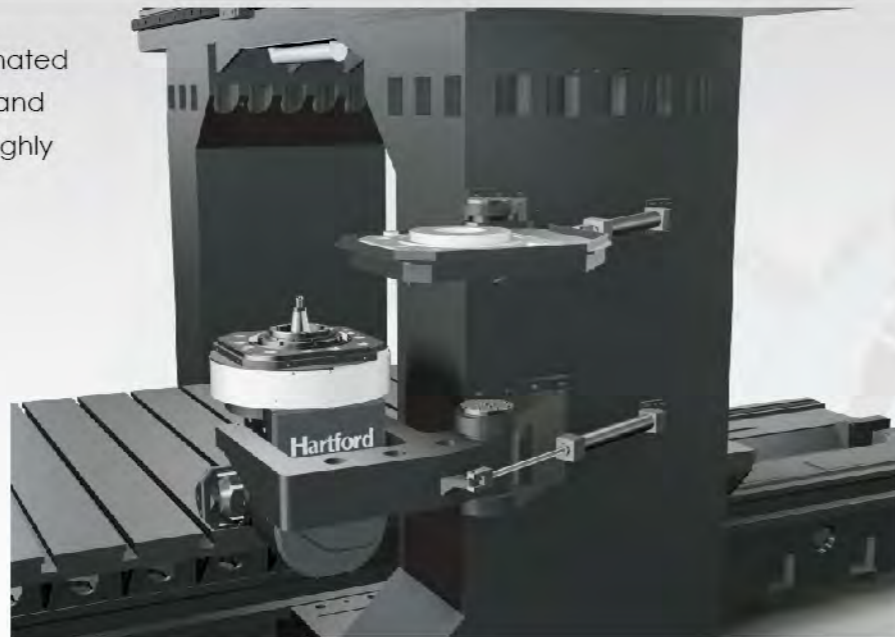

EA/EAY jib head compartment module

- It can be used with automatic universal head / automatic 90-degree head / automatically extension head.
- Fully automated exchange head compartment is fitted with protective cover and independent angle head compartment.
- It is designed to be driven by a hydraulic cylinder to provide the angle head fast switching capability.
- Each compartment is fitted with an independent movable door, which opens only during switching of the head, to prevent chips from contaminating angle head.

Choose a variety of tool magazines

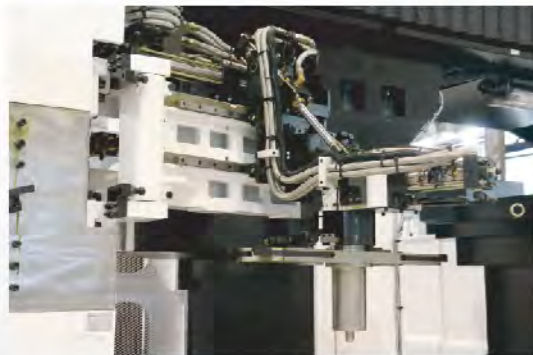

1.The vertical and horizontal tool magazine



2.Vertical tool magazine

- Automatic switching processing tool
- All tool change action and tool change points are fitted with detector and sequential scanning to ensure stability and reliability for machine tool change.
- Vertical type tool magazine : can be used with 32/40/60/90 tools(standard feature).
- Vertical and horizontal tool magazine: can be used with 32/40/62 tools (optional configuration)

Automatic angular head machining patterns

Working patterns	1.Composite bevel sharp cutting processing	2. 90 degrees side sharp machining	3.Elongation sharp cutting processing
Product form	AC universal head	90 degrees side cutting head	350/500mm extension head
Model code	HF-AU360H	HF-A90L/H	HF-AE35/50L
Maximum speed(rpm)	4000	4000	4000
Tool form	BT50	BT50	BT50
Automatic indexing	5°/2.5°/1°	5°/2.5°/1°	-
Automatic switching head	Automatic	Automatic	Automatic
Automatic tool changing	Automatic	Automatic	Automatic
Rotation angle	C : ±180° A : ±110°	±180°	-



Application of automatic 90° head

Angular head cutting ability actual test data

Spindle motor specifications : a30*7000rpm*37kw(gear type)

Angle head	Auto AC universal axis (1°)		
Test models	HSA-428EAY	HSA-428EAY	HSA-428EAY
Angle	A-90/C90	C0/A90	C0/A0
Test item	Face milling/end milling	Face milling/end milling	Face milling/end milling
Test Results	1200(32.4cc/kw)/792(21.4cc/kw)	1200(32.4cc/kw)/792(21.4cc/kw)	1200(32.4cc/kw)/456(12.3cc/kw)
The maximum depth of cut(mm)	5/10 x 40	5/10 x 40	5/10 x 40

Test item	The maximum test size (mm)	Spindle current ratio(%)
Drilling (violent drilling)	ø76	38
Tapping	M32	16



The new Y-axis is designed to bring a broader range of processing

ALL NEW INFINITY series models providing increased Y-axis travel design, you can upgrade you range of processing through the increase of Y-axis travel. We have achieved our purpose to process the widest range with the minimum cost.

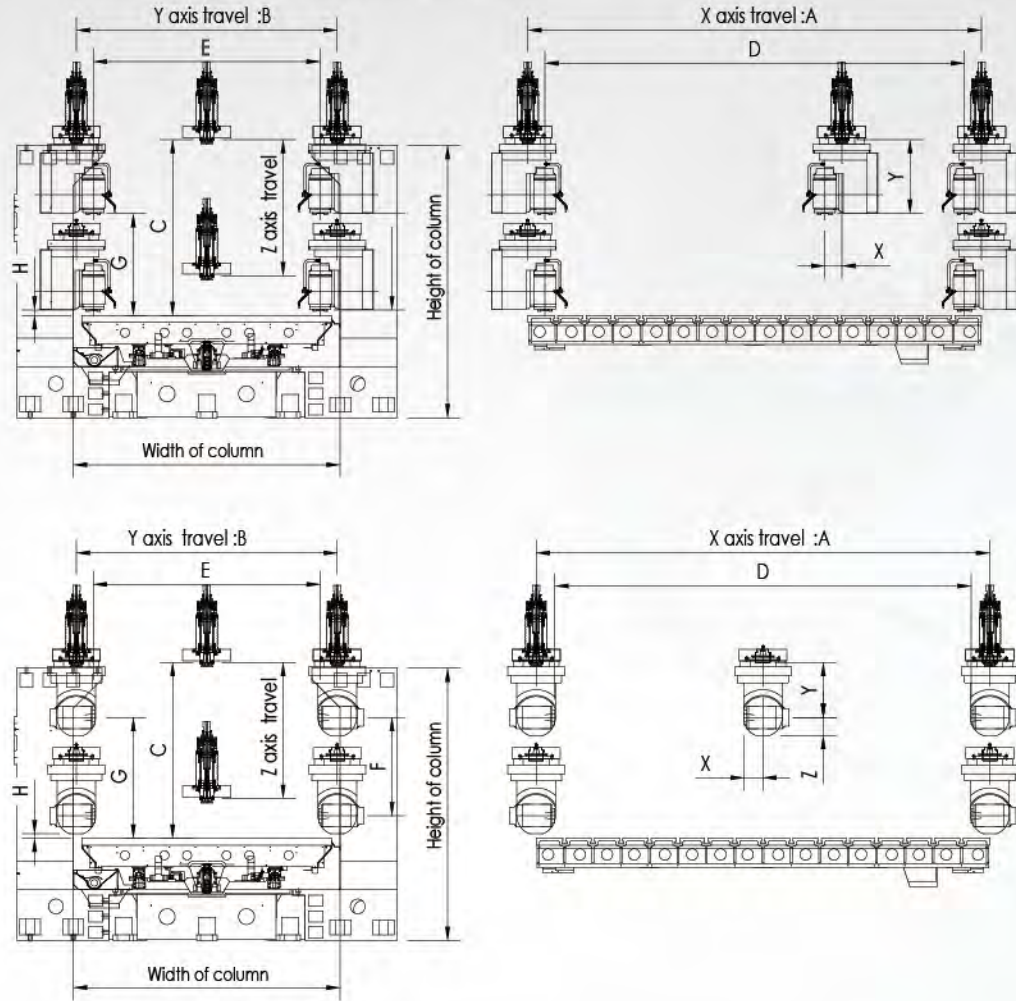

Model	Z-TRAVEL	COLUMN-HIGH	COLUMN-WIDTH	B	C	E(V)	F(V)	E(H)	F(H)	G(H)	H	
						B-(X*2)	C-(Y+H)	G(V)	B-(X*2)			C-(Y+H)
HSA-X23EA	1000	2200	2300	2300	1350	2000	650	1970	655	865	50	
HSA-X23EAY				3100	2800	650	700	2770	655	865		
HSA-X27EA			2700	2700	1350	2400	650	700	2370	655		865
HSA-X27EAY				3500	3200	650	700	3170	655	865		
HSA-X28EA			2800	2800	1310	2500	610	660	2470	615		825
HSA-X28EAY				3600	3300	610	660	3270	615	825		
HSA-X32EA			3200	3200	1310	2900	610	660	2870	615		825
HSA-X32EAY				4000	3700	610	660	3670	615	825		
HSA-X36EA			3600	3600	1310	3300	610	660	3270	615		825
HSA-X36EAY				4400	4100	610	660	4070	615	825		

QC cutting ability test present the beat quality of Hartford

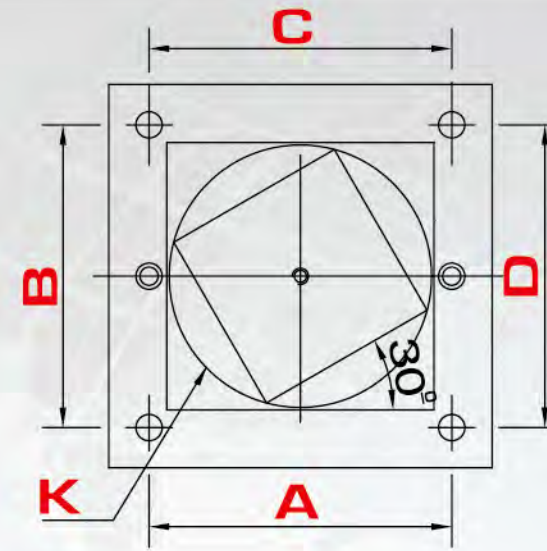

HSA-423 Mold Testing

- Test materials : F25C
- Cutting speed : F200-500
- Spindle speed : S500-800
- Test tool diameter : ø25mm

	Positioning machining precision Positioning accuracy				Through FIG cutting accuracy Precision through FIG.	unit(mm)
	A	B	C	D	K	
Error value	0.025	0.025	0.025	0.025	0.020	
Actual value	0.0016 (⊕)	0.0015 (⊕)	0.0070 (⊕)	0.0019 (⊕)	0.0037 (○)	

Accuracy	Error value	The actual value
The true flatness of bed top surface(X/Y-axis)	1000▼0.05/M, 1000-2000▲0.06/M, 2000 0.07/M	0.02
Right angle of mutual movement of each axis(X/Y-axis)	0.020/500	0.005
Right angle of mutual movement of each axis(Y/Z-axis)	0.02/500	0.005
Slanting swing in spindle hole	Fixed Side : 0.005, Free Side : 0.012/300	0.001/0.005
Accuracy through roundness	0.012/150(X-axis 5000以上 0.020/150)	0.003

2.Manual position head (manually fixed) applicable to general model HSA



Universal head (manual/semi-automatic)		Manual universal head	Semi-automatic universal head
		A-axis : ±110°, C-axis : ±180° Maximum speed:2,500rpm Maximum power:18.5kw The maximum torque to withstand: 650N-m	Binding mechanism
	Unclamping mechanism	Manual	Automatic
	C-axis rotation	Manual	Manual



90° side milling head (manual / semi-automatic)		Manual 90° head	Semiautomatic 90° head
		Manual tool change(manual / hydraulic lock release tool.) Maximum speed:2,000rpm Maximum power:18.5kW The maximum torque to withstand: 650N-m	Binding mechanism
	Unclamping mechanism	Manual	Automatic
	C-axis rotation	Manual	Manual



Extension head (350/500mm)
Maximum speed : 4,000rpm
Maximum power : 18.5kW
The maximum torque to withstand : 650N-m

A variety of Hartford made spindles have Quality assurance

Torque curve diagram

- 6,000 rpm gear type spindle
- 8,000rpm gear type spindle(optional configuration)
- 10,000rpm direct-connected spindle(optional configuration)
- 12,000rpm direct-connected spindle(optional configuration)
- 15,000rpm direct-connected spindle(optional configuration)
- Hybrid 10,000rpm spindle (optional configuration is applicab to EA/EAY)

Hybrid 10,000RPM(opt.)

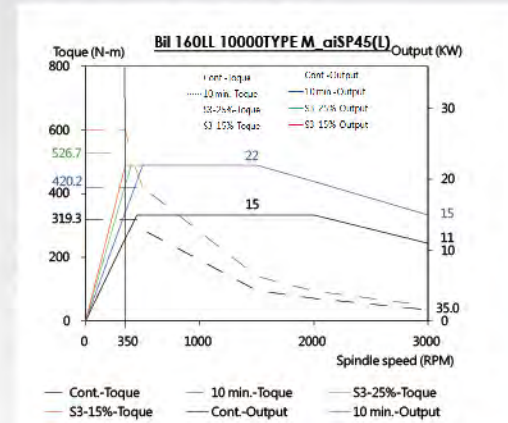

Direct type

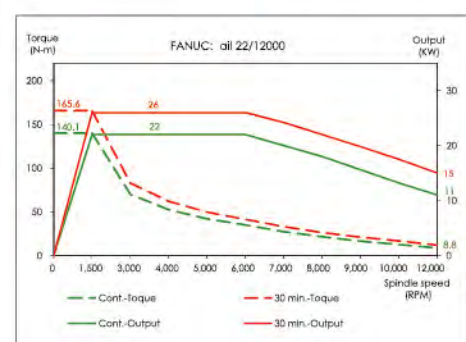
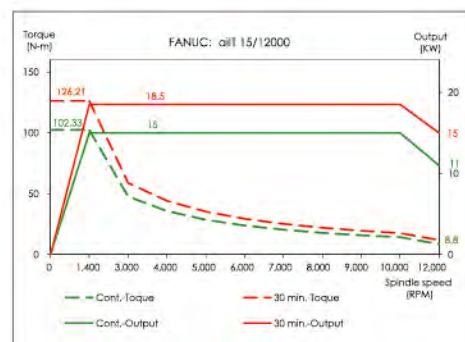
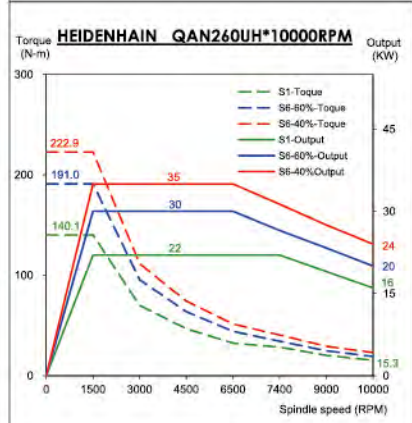
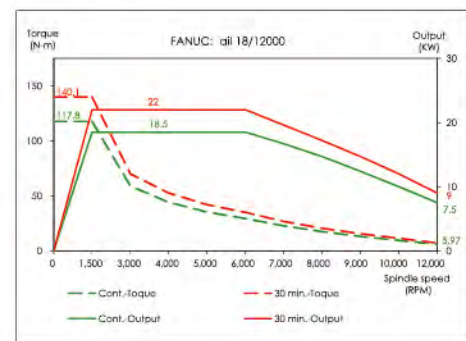
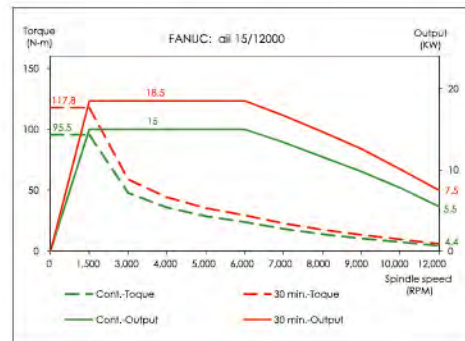
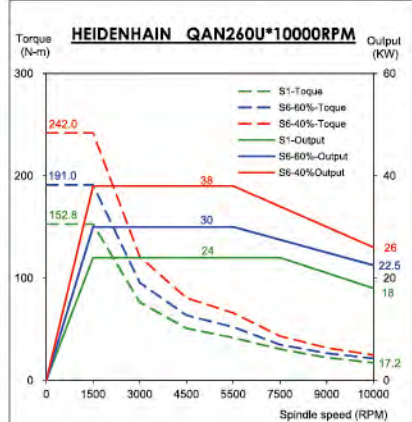
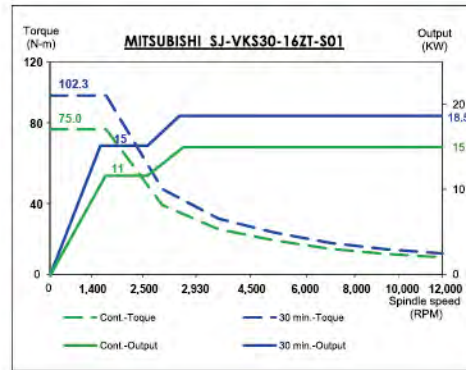
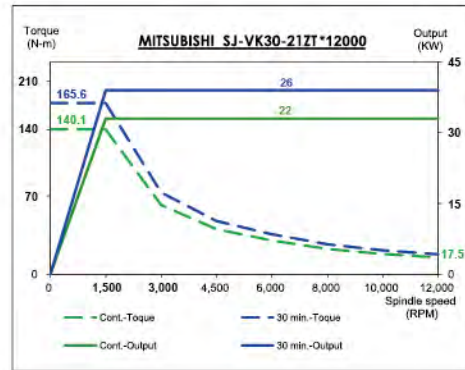
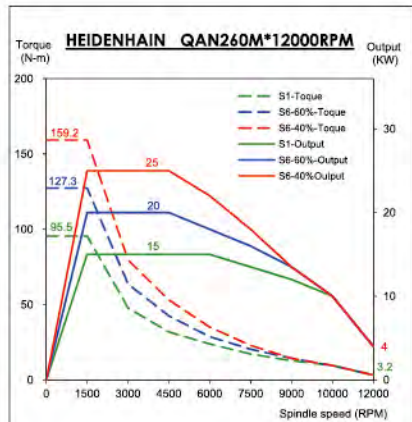

Gear type 6,000RPM

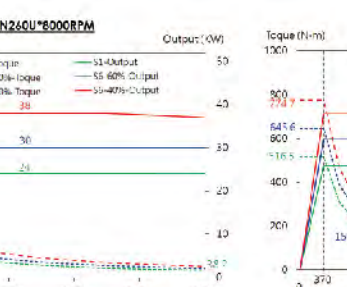
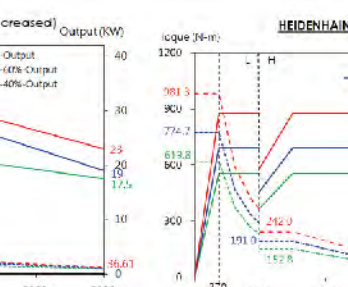
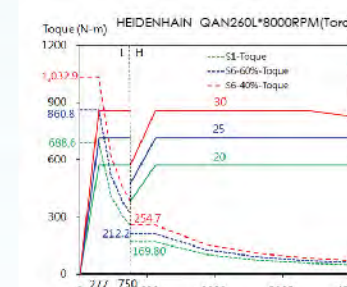
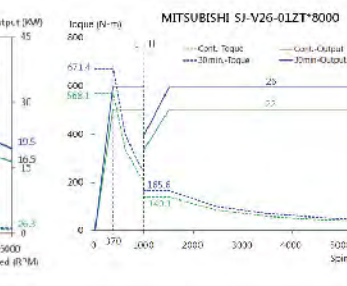
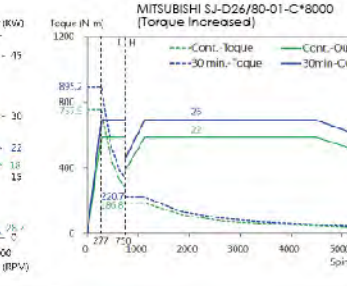
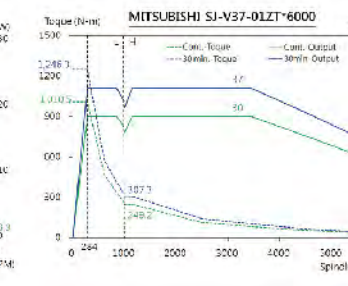
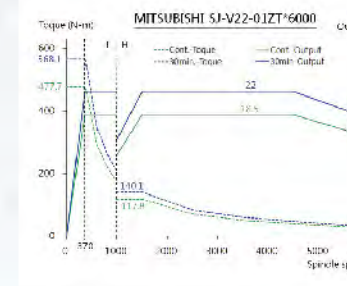
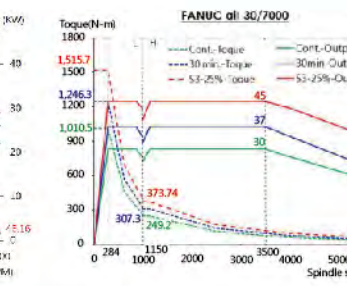
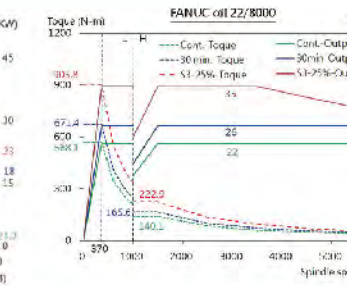
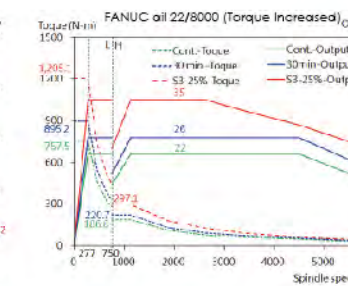
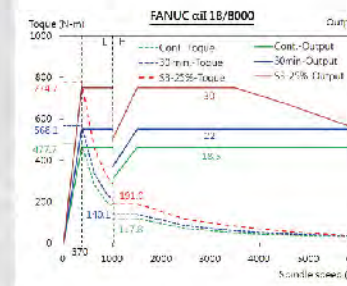

Gear type 8,000RPM

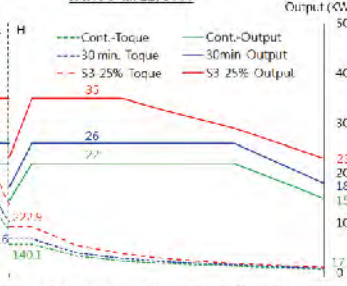
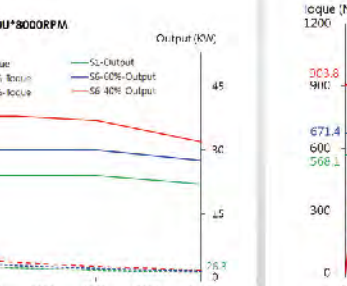
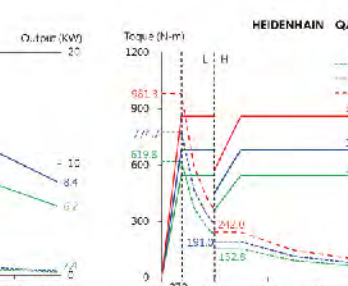
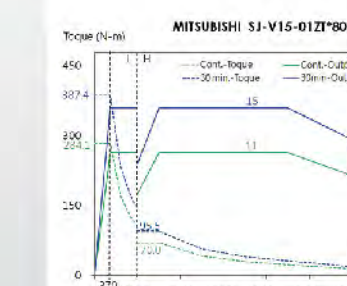
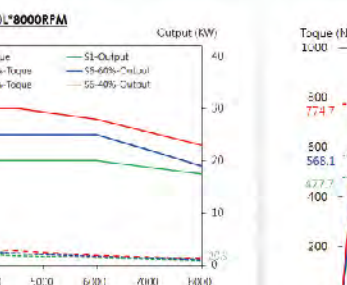
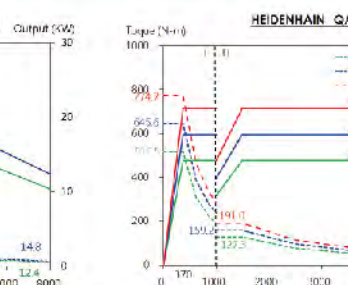
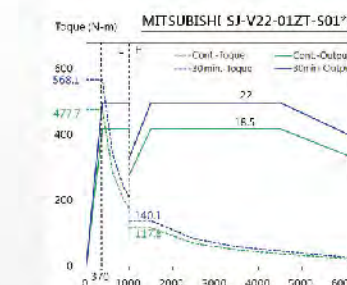

Machine Dimension

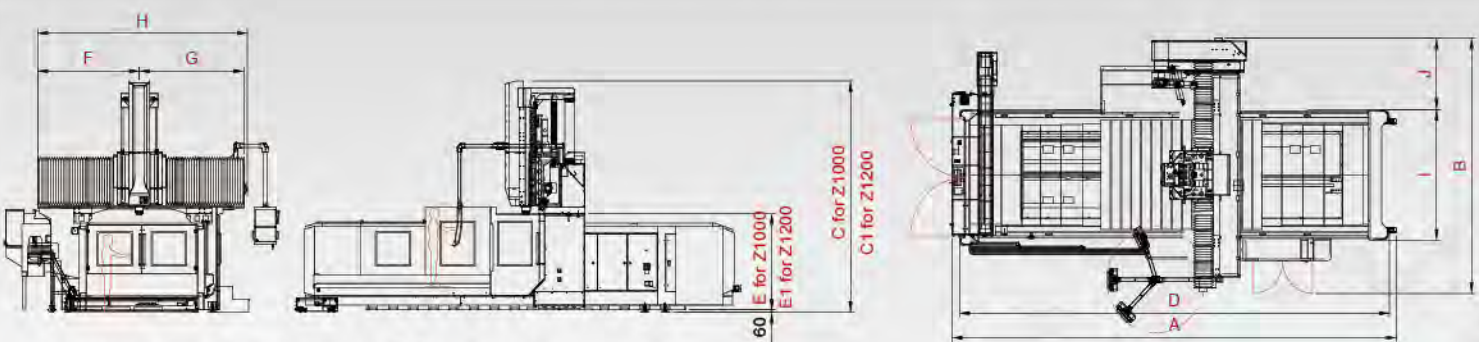

HSA-X23/X27/X28/X32/X36系列(EA/EAY)

Model	A	B	C	C1	D	E	E1	F	G	H	I	J
HSA-323EA	9000	5340	5235	5635	8795	2200	2400	2205	2265	4625	2494	1630
HSA-423EA	11000	5340	5235	5635	10795	2200	2400	2205	2265	4625	2494	1630
HSA-523EA	13000	5340	5235	5635	12795	2200	2400	2205	2265	4625	2494	1630
HSA-623EA	15000	5340	5235	5635	14795	2200	2400	2205	2265	4625	2494	1630
HSA-327EA	9000	5840	5235	5635	8795	2200	2400	2525	2585	5195	2994	1630
HSA-427EA	11000	5840	5235	5635	10795	2200	2400	2525	2585	5195	2994	1630
HSA-527EA	13000	5840	5235	5635	12795	2200	2400	2525	2585	5195	2994	1630
HSA-627EA	15000	5840	5235	5635	14795	2200	2400	2525	2585	5195	2994	1630
HSA-328EA	9000	5840	5235	5635	8795	2200	2400	2525	2585	5195	2994	1630
HSA-428EA	11000	5840	5235	5635	10795	2200	2400	2525	2585	5195	2994	1630
HSA-528EA	13000	5840	5235	5635	12795	2200	2400	2525	2585	5195	2994	1630
HSA-628EA	15000	5840	5235	5635	14795	2200	2400	2525	2585	5195	2994	1630
HSA-728EA	17000	5840	5235	5635	16795	2200	2400	2525	2585	5195	2994	1630
HSA-828EA	19000	5840	5235	5635	18795	2200	2400	2525	2585	5195	2994	1630
HSA-532EA	13000	6490	5235	5635	12795	2200	2400	2750	2810	5670	3394	1630
HSA-732EA	17000	6490	5235	5635	16795	2200	2400	2750	2810	5670	3394	1630
HSA-832EA	19000	6490	5235	5635	18795	2200	2400	2750	2810	5670	3394	1630
HSA-536EA	13000	6990	5235	5635	12795	2200	2400	3025	3085	6195	3794	1715
HSA-736EA	17000	6990	5235	5635	16795	2200	2400	3025	3085	6195	3794	1715
HSA-836EA	19000	6990	5235	5635	18795	2200	2400	3025	3085	6195	3794	1715
HSA-323EAY	9000	5590	5235	5635	8795	2200	2400	2625	2535	5225	2494	1880
HSA-423EAY	11000	5590	5235	5635	10795	2200	2400	2625	2535	5225	2494	1880
HSA-523EAY	13000	5590	5235	5635	12795	2200	2400	2625	2535	5225	2494	1880
HSA-623EAY	15000	5590	5235	5635	14795	2200	2400	2625	2535	5225	2494	1880
HSA-327EAY	9000	6090	5235	5635	8795	2200	2400	2875	2785	5725	2994	1880
HSA-427EAY	11000	6090	5235	5635	10795	2200	2400	2875	2785	5725	2994	1880
HSA-527EAY	13000	6090	5235	5635	12795	2200	2400	2875	2785	5725	2994	1880
HSA-627EAY	15000	6090	5235	5635	14795	2200	2400	2875	2785	5725	2994	1880
HSA-328EAY	9000	6090	5235	5635	8795	2200	2400	2875	2785	5725	2994	1880
HSA-428EAY	11000	6090	5235	5635	10795	2200	2400	2875	2785	5725	2994	1880
HSA-528EAY	13000	6090	5235	5635	12795	2200	2400	2875	2785	5725	2994	1880
HSA-628EAY	15000	6090	5235	5635	14795	2200	2400	2875	2785	5725	2994	1880
HSA-728EAY	17000	6090	5235	5635	16795	2200	2400	2875	2785	5725	2994	1880
HSA-828EAY	19000	6090	5235	5635	18795	2200	2400	2875	2785	5725	2994	1880
HSA-532EAY	13000	6740	5235	5635	12795	2200	2400	3100	3010	6220	3394	1880
HSA-732EAY	17000	6740	5235	5635	16795	2200	2400	3100	3010	6220	3394	1880
HSA-832EAY	19000	6740	5235	5635	18795	2200	2400	3100	3010	6220	3394	1880
HSA-536EAY	13000	7240	5235	5635	12795	2200	2400	3275	3185	6525	3794	1965
HSA-736EAY	17000	7240	5235	5635	16795	2200	2400	3275	3185	6525	3794	1965
HSA-836EAY	19000	7240	5235	5635	18795	2200	2400	3275	3185	6525	3794	1965

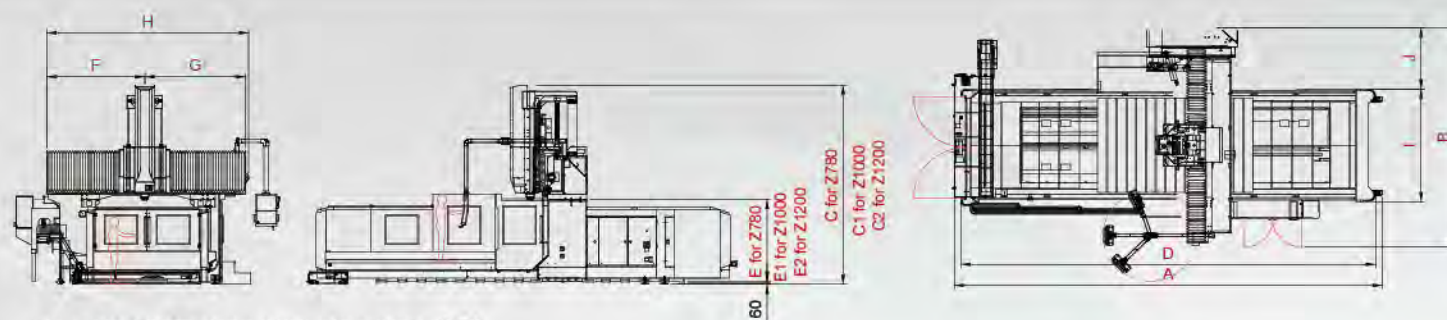

HSA-X20/X23/X27/X28/X32/X36系列

Model	A	B	C	C1	C2	D	E	E1	E2	F	G	H	I	J
HSA-320	9000	5040	4800/4900	5300	5700	8795	1900/2000	2200	2400	2130	2190	4400	2194	1630
HSA-420	11000	5040	4800/4900	5300	5700	10795	1900/2000	2200	2400	2130	2190	4400	2194	1630
HSA-323	9000	5340	4800/4900	5300	5700	8795	1900/2000	2200	2400	2205	2265	4625	2494	1630
HSA-423	11000	5340	4800/4900	5300	5700	10795	1900/2000	2200	2400	2205	2265	4625	2494	1630
HSA-523	13000	5340	4800/4900	5300	5700	12795	1900/2000	2200	2400	2205	2265	4625	2494	1630
HSA-623	15000	5340	4800/4900	5300	5700	14795	1900/2000	2200	2400	2205	2265	4625	2494	1630
HSA-327	9000	5840	4800/4900	5300	5700	8795	1900/2000	2200	2400	2525	2585	5195	2994	1630
HSA-427	11000	5840	4800/4900	5300	5700	10795	1900/2000	2200	2400	2525	2585	5195	2994	1630
HSA-527	13000	5840	4800/4900	5300	5700	12795	1900/2000	2200	2400	2525	2585	5195	2994	1630
HSA-627	15000	5840	4800/4900	5300	5700	14795	1900/2000	2200	2400	2525	2585	5195	2994	1630
HSA-328	9000	5840	4900	5300	5700	8795	2000	2200	2400	2525	2585	5195	2994	1630
HSA-428	11000	5840	4900	5300	5700	10795	2000	2200	2400	2525	2585	5195	2994	1630
HSA-528	13000	5840	4900	5300	5700	12795	2000	2200	2400	2525	2585	5195	2994	1630
HSA-628	15000	5840	4900	5300	5700	14795	2000	2200	2400	2525	2585	5195	2994	1630
HSA-728	17000	5840	4900	5300	5700	16795	2000	2200	2400	2525	2585	5195	2994	1630
HSA-828	19000	5840	4900	5300	5700	18795	2000	2200	2400	2525	2585	5195	2994	1630
HSA-432	11000	6240	4900	5300	5700	10795	2000	2200	2400	2750	2810	5670	3394	1630
HSA-532	13000	6240	4900	5300	5700	12795	2000	2200	2400	2750	2810	5670	3394	1630
HSA-832	19000	6240	4900	5300	5700	18795	2000	2200	2400	2750	2810	5670	3394	1630
HSA-436	11000	6740	4900	5300	5700	10795	2000	2200	2400	3025	3085	6195	3794	1730
HSA-536	13000	6740	4900	5300	5700	12795	2000	2200	2400	3025	3085	6195	3794	1730
HSA-636	15000	6740	4900	5300	5700	14795	2000	2200	2400	3025	3085	6195	3794	1730
HSA-736	17000	6740	4900	5300	5700	16795	2000	2200	2400	3025	3085	6195	3794	1730
HSA-836	19000	6740	4900	5300	5700	18795	2000	2200	2400	3025	3085	6195	3794	1730

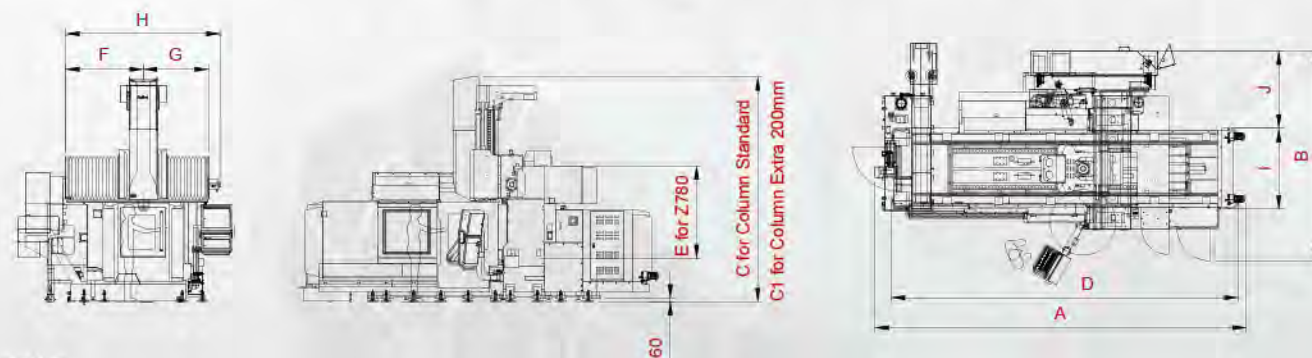

HSA-2212

Model	A	B	C	C1	D	E	F	G	H	I	J
HSA-2212	6800	3855	4120	4320	6355	1700	1423.5	1193.5	2832.5	1480	1425

Mechanical Specifications Table

Model	Unit	HSA-323/423/523/623(EA)	HSA-327/427/527/627(EA)	HSA-328/428/528/628/728/828(EA)	HSA-532/732/832(EA)	HSA-536/736/836(EA)			
Workbench	Workbench size	mm	3000/4000/5000/6000 x2200	3000/4000/5000/6000 x2200	3000/4000/5000/6000/7000/8000 x2500	5000/7000/8000 x3000			
	T-shaped slot (slot frame x slot number x slot distance)	mm	28 x 11/15/19/23 x250	28 x 11/15/19/23 x250	28 x 11/15/19/23/27/31 x250	28 x 19/27/31 x250			
	Maximum load	kg	10000/12000/15000/18000	10000/12000/15000/18000	15000/18000/20000/23000/25000/27000	20000/25000/27000			
	X-axis travel	mm	3000/4000/5000/6000	3000/4000/5000/6000	3000/4000/5000/6000/7000/8000	5000/7000/8000			
Travel	Y-axis travel	mm	EA:2300 EAY:3100	EA:2700 EAY:3500	EA:2800 EAY:3600	EA:3200 EAY:4000			
	Z-axis travel	mm	1000(1200)	1000(1200)	1000(1200)	1000(1200)			
	Spindle nose to workbench	mm	350~1350(Z:1000_Column 2200) 350~1550(Z:1200_Column 2400)	350~1350(Z:1000_Column 2200) 350~1550(Z:1200_Column 2400)	310~1310(Z:1000_Column 2200) 310~1510(Z:1200_Column 2400)	310~1310(Z:1000_Column 2200) 310~1510(Z:1200_Column 2400)			
	Spindle center to column	mm	450	450	450	450			
Spindle	Door width	mm	2300	2800	2800	3200			
	Gear type speed	rpm	6000(8000)	6000(8000)	6000(8000)	6000(8000)			
	Direct-connected type speed	rpm	10000	10000	10000	10000			
	Nose taper		ISO50	ISO50	ISO50	ISO50			
Speed	Cut rate(X / Y / Z axis)	mm/min	12000/12000/12000(323) 10000/12000/12000(423) 8000/12000/12000(523) 8000/12000/12000(623)	12000/12000/12000(327) 10000/12000/12000(427) 8000/12000/12000(527) 8000/12000/12000(627)	10000/12000/12000(328) 10000/12000/12000(428) 8000/12000/12000(528) 8000/12000/12000(628) 8000/12000/12000(728) 6000/12000/12000(828)	8000/12000/12000(532) 8000/12000/12000(732) 6000/12000/12000(832)	8000/12000/12000(536) 8000/12000/12000(736) 6000/12000/12000(836)		
		Feed rate(X / Y / Z axis)	mm/min	20000/18000/16000(323) 20000/18000/16000(423) 14000/18000/16000(523) 12000/18000/16000(623)	20000/18000/16000(327) 20000/18000/16000(427) 14000/18000/16000(527) 12000/18000/16000(627)	20000/18000/16000(328) 16000/18000/16000(428) 12000/18000/16000(528) 10000/18000/16000(628) 10000/18000/16000(728) 8000/18000/16000(828)	12000/18000/16000(532) 10000/18000/16000(732) 8000/18000/16000(832)	14000/16000/16000(536) 10000/16000/16000(736) 8000/18000/16000(836)	
			Automatic Tool Changer	Tool number	pcs	32(40/60/90) A-type	32(40/60/90) A-type	32(40/60/90) A-type	32(40/60/90) A-type
				Maximum tool weight	kg	20	20	20	20
Tool size (diameter x length)	mm			Ø125 x 400	Ø125 x 400	Ø125 x 400	Ø125 x 400		
Tool holder		BT50/BBT50/CAT50/DIN		BT50/BBT50/CAT50/DIN	BT50/BBT50/CAT50/DIN	BT50/BBT50/CAT50/DIN			
Motor	Pulling bolt		P50T-1	P50T-1	P50T-1	P50T-1			
	Spindle power(Fanuc)	kw (30min/con)	22/18.5 35/30(複合式主軸for Fanuc)	22/18.5 35/30(複合式主軸for Fanuc)	22/18.5 35/30(複合式主軸for Fanuc)	22/18.5 35/30(複合式主軸for Fanuc)			
	Positioning accuracy	3-axis laser positioning accuracy(JIS B6330)							
		Positioning accuracy / full travel	mm	±0.010/0.010/0.012/0.012	±0.010/0.010/0.012/0.012	±0.010/0.010/0.012/0.012	±0.012		
Repeated positioning accuracy		mm	±0.003	±0.003	±0.003	±0.003			
3-axis laser positioning accuracy(VDI 3441)repeat 5 time									
Other	Positioning accuracy	mm	0.016/0.018/0.026/0.028	0.016/0.018/0.026/0.028	0.016/0.018/0.026/0.028/0.030	0.026/0.028/0.030			
	Repeated positioning accuracy	mm	0.014/0.015/0.021/0.024	0.014/0.015/0.021/0.024	0.014/0.015/0.021/0.024/0.026	0.021/0.024/0.026			
	Required air pressure	kg/cm ²	6.5	6.5	6.5	6.5			
	Required power	kVA	45~70	45~65	45~60(328/428) 45~65(528/628/728/828)	40~70(532) 45~70(632/732/832)	45~70		
Other	Covering area	mm	11000/13000/15000/17000x6800(EA) 11000/13000/15000/17000x7050(EAY)	11000/13000/15000/17000x7300(EA) 11000/13000/15000/17000x7550(EAY)	11000/13000/15000/17000/1900/2100x7300(EA) 11000/13000/15000/17000/1900/2100x7550(EAY)	15000/1900/2100x7700(EA) 15000/1900/2100x7950(EAY)			
		Net weight	kg	32000/36000/40000/44000(EA) 33500/37500/41500/45500(EAY)	35300/39300/43300/47500(EA) 36800/40800/44800/49000(EAY)	36300/41300/43600/51300/56300/61300(EA) 37800/42800/47800/52800/57800/62800(EAY)	46500/57500/62500(EA) 48000/59000/64000(EAY)		
						58000/68000/73000(EA) 59500/69500/74500(EAY)			

Mechanical Specifications Table

Model	Unit	HSA-2212	HSA-320/420	HSA-323/423/523/623	HSA-327/427/527/627	HSA-328/428/528/628/728/828	HSA-432/532/832	HSA-436/536/636/736/836	
Workbench	Workbench size	mm	2000 x 1100	3000/4000 x 1800	3000/4000/5000/6000 x 2200	3000/4000/5000/6000/7000/8000 x 2500	4000/5000/8000 x 2500	4000/5000/6000/7000/8000 x 3000	
	T-shaped slot (slot frame x slot number x slot distance)	mm	22 x 6 x 160	22 x 11/15 x 250	28 x 11/15/19/23 x 250	28 x 11/15/19/23/27/31 x 250	28 x 11/15/19/31 x 250	28 x 15/19/23/27/31 x 250	
	Maximum load	kg	3500	10000/12000	10000/12000/15000/18000	10000/12000/15000/18000	15000/18000/20000/23000/25000/27000	18000/20000/27000	18000/21000/24000/27000/30000
	X-axis travel	mm	2250	3000/4000	3000/4000/5000/6000	3000/4000/5000/6000	3000/4000/5000/6000/7000/8000	4000/5000/8000	4000/5000/6000/7000/8000
Travel	Y-axis travel	mm	1200	2000	2300	2700	2800	3200	3600
	Z-axis travel	mm	780	780(1000/1200)	780(1000/1200)	780(1000/1200)	780(1000/1200)	780(1000/1200)	780(1000/1200)
	Spindle nose to workbench	mm	180~960(Z:780_Column 1700)#40 380~1160(Z:780_Column 1900)#40 120~900(Z:780_Column 1700)#50 320~1100(Z:780_Column 1900)#50	340~1340(Z:1000_Column 2200)#40 340~1540(Z:1200_Column 2400)#40 280~1280(Z:1000_Column 1900)#50 280~1480(Z:1200_Column 2400)#50	260~1040(Z:780_Column 1900)#40 340~1340(Z:1000_Column 2200)#40 340~1540(Z:1200_Column 2400)#40 200~980(Z:780_Column 1900)#50 280~1280(Z:1000_Column 2200)#50 280~1480(Z:1200_Column 2400)#50	200~980(Z:780_Column 1900)#50 280~1280(Z:1000_Column 2200)#50 280~1480(Z:1200_Column 2400)#50	260~1040(Z:780_Column 1900) 240~1340(Z:1000_Column 2200) 240~1540(Z:1200_Column 2400)	260~1040(Z:780_Column 1900) 240~1340(Z:1000_Column 2200) 240~1440(Z:1200_Column 2400)	260~1040(Z:780_Column 2000) 240~1240(Z:1000_Column 2200) 240~1440(Z:1200_Column 2400)
	Spindle center to column	mm	450	450	450	450	450	450	450
Spindle	Door width	mm	1300	2000	2300	2800	2800	3200	3600
	Gear type speed	rpm	6000(8000)	6000(8000)	6000(8000)	6000(8000)	6000(8000)	6000(8000)	6000(8000)
	Direct-connected type speed	rpm	10000(15000 only on #40)	#50:10000/12000 #40:15000/20000	#50:10000/12000 #40:15000/20000	10000/12000	10000/12000	10000/12000	10000/12000
	Nose taper		ISO50/40	ISO50	ISO50	ISO50	ISO50	ISO50	ISO50
Speed	Cut rate(X / Y / Z axis)	mm/min	10000	12000	12000/12000(323) 10000/12000/12000(423) 8000/12000/12000(523) 8000/12000/12000(623)	12000/12000(327) 10000/12000/12000(427) 8000/12000/12000(527) 8000/12000/12000(627)	10000/12000(328) 10000/12000/12000(428) 8000/12000/12000(528) 8000/12000/12000(628) 8000/12000/12000(728) 6000/12000/12000(828)	10000/12000/12000(432) 8000/12000/12000(532) 6000/12000/12000(828)	10000/10000/10000(436) 8000/10000/10000(536) 8000/10000/10000(736) 6000/10000/10000(836)
	Feed rate(X / Y / Z axis)	mm/min	24000/24000/20000	20000/18000/16000(320) 20000/18000/16000(420)	20000/18000/16000(323) 20000/18000/16000(423) 14000/18000/16000(523) 12000/18000/16000(623)	20000/18000/16000(327) 20000/18000/16000(427) 14000/18000/16000(527) 12000/18000/16000(627)	20000/18000/16000(328) 16000/18000/16000(428) 12000/18000/16000(528) 10000/18000/16000(628) 10000/18000/16000(728) 85000/18000/16000(828)	16000/18000/16000(432) 12000/18000/16000(532) 8000/18000/16000(832)	16000/16000/16000(436) 14000/16000/16000(536) 12000/16000/16000(636) 10000/16000/16000(736) 8000/16000/16000(836)
	Tool number	pcs	24/32 A-type, 40A-type Only on #50	32/40/60 A-type	32/40/60 A-type	32/40/60 A-type	32/40/60 A-type	32 A-type	32/40/60 A-type
	Maximum tool weight	kg	18(#50),7(#40)	20(#50) · 7(#40)	20(#50) · 7(#40)	20A-type	20A-type	20A-type	20A-type
Automatic Tool Changer	Tool size (diameter x length)	mm	Ø110 x 350L(24)/Ø125x350L(32/40) (Ø75x 300L Only on #40)	Ø125 x 400L(A-type) (Ø75x 300L Only on #40)	Ø125 x 400L(A-type) (Ø75x 300L Only on #40)	Ø125 x 400L(A-type)	Ø125 x 400L(A-type)	Ø125 x 400L(A-type)	
	Tool holder		BT50(BBT40.50/CAT40.50/DIN)	BBT/BT/CAT/DIN69871(#40/#50) · HSK-A63(#40)	BBT/BT/CAT/DIN69871(#40/#50) · HSK-A63(#40)	BBT/BT/CAT/DIN69871	BBT/BT/CAT/DIN69871	BT50/BBT50/CAT50/DIN	BBT/BT/CAT/DIN69871
	Pulling bolt		P50T-1/CAT-50/DIN, MAS-P40T-1/CAT-40/DIN	MAS-P50T-1(#50)/ MAS-P40T-1(#40)/DIN69872	MAS-P50T-1(#50)/ MAS-P40T-1(#40)/DIN69872	MAS-P50T-1/DIN69872	MAS-P50T-1/DIN69872	P50T-1	MAS-P50T-1/DIN69872
Motor	Spindle power(Fanuc)	kW (30min/con)	#50:18.5/15(22/26 DDS for Fanuc) #40:11/7.5 DDS for Fanuc	#50:18.5/22(15/18.5 DDS for Fanuc) #40:7.5/11 DDS for Fanuc	#50:18.5/22(15/18.5 DDS for Fanuc) #40:7.5/11 DDS for Fanuc	18.5/22(15/18.5 DDS for Fanuc)	18.5/22(15/18.5 DDS for Fanuc)	22/18.5	18.5/22(15/18.5 DDS for Fanuc)
	3-axis laser positioning accuracy(JIS B6330)								
Positioning accuracy	Positioning accuracy / full travel	mm	±0.010	±0.010	±0.010/0.010/0.012/0.012	±0.010/0.010/0.012/0.012	±0.010/0.010/0.012/0.012/0.012/0.012	±0.012	±0.012
	Repeated positioning accuracy	mm	±0.003	±0.003	±0.003	±0.003	±0.003	±0.003	±0.003
	3-axis laser positioning accuracy(VDI3441)repeat 5 time								
	Positioning accuracy	mm	0.015	0.016/0.018	0.016/0.018/0.020/0.028	0.016/0.018/0.020/0.028	0.016/0.018/0.026/0.028/0.028/0.030	0.018/0.026/0.030	0.018/0.026/0.028/0.028/0.030
Repeated positioning accuracy	mm	0.014	0.014/0.015	0.014/0.015/0.021/0.024	0.014/0.015/0.021/0.024	0.014/0.015/0.021/0.024/0.024/0.026	0.015/0.021/0.026	0.015/0.021/0.024/0.024/0.026	
Other	Required air pressure	kg/cm ²	6.5	6.5	6.5	6.5	6.5	6.5	
	Required power	kVA	25~65(#40)/35~65(#50)	40-70	40-75(323/423/523) 45~75(623/723)	40-75(327/427/527) 45~75(627)	40-75(328/428/528) 45~75(628/728/828)	40-75(432) 45~70(532)45~75(832)	45~75
	Covering area	mm	8535x5745	11000/13000x6600	11000/13000/15000/17000x6900	11000/13000/15000/17000x7400	11000/13000/15000/17000/19000/21000x7500	13440/15440/21440x7680	13000/15000/17000/19000/21000x8300
	Net weight	kg	14720	24500/27500/30500(Z-axis 780) 25500/28500/31500(Z-axis 1000) 26500/29500/32500(Z-axis 1200)	30100/34100/38100/42100(Z-axis 780) 31420/35420/39420/43420(Z-axis 1000) 32000/36200/40200/44200(Z-axis 1200)	33370/37370/41370/45370(Z-axis 780) 34690/38690/42690/46690(Z-axis 1000) 35470/39470/43470/47470(Z-axis 1200)	34000/39000/44000/50000/55000/60000(Z-axis 780) 34500/39500/44500/50500/55500/60500(Z-axis 1000) 35000/40000/45000/51500/56500/61500(Z-axis 1200)	41000/46000/62000(Z-axis 780) 41500/46500/62500(Z-axis 1000) 42000/47000/63000(Z-axis 1200)	50000/56000/62000/67000/72000(Z-axis 780) 50500/56500/62500/72500(Z-axis 1000) 51000/57000/63000/68000/73000(Z-axis 1200)

Accessories

Standard : ● Optional : ★

item	model	HSA-x23(EA)	HSA-x27(EA)	HSA-x28(EA)	HSA-x32(EA)
1.5 Years Warranty_Linear Guide Way		●	●	●	●
2.Spindle Air Curtain		●	●	●	●
3.Air Blast Through Spindle		●	●	●	●
4.Table Side Air Blast (1 tube)		●	●	●	●
5.Centralized Automatic Lubrication System		●	●	●	●
6.Screw type chip conveyor		●	●	●	●
7.Tool package		●	●	●	●
8.Without Mist coolant system		●	●	●	●
9.Foundation bolt		●	●	●	●
10.Absolute pulse coder		●	●	●	●
11.Spindle Oil Cooler		●	●	●	●
12Automatic Power off		●	●	●	●
13.Operation Finish Lamp		●	●	●	●
14.Foot Switch For Spindle Clamp/Unclamp		●	●	●	●
15.Remote Manual Pulse Generator		●	●	●	●
16.RS-232 Interface		●	●	●	●
17.Habor Convection Heat Exchanger In Control Box		●	●	●	●
18.Fluorescentx1		●	●	●	●
19. Link type chip conveyor 0.19 KW(Without Coolant Tank) & portable chip bucket(1 EA)		●	●	●	●
20.Manual x1		●	●	●	●
21.6000RPM Gear Head		●	●	●	●
22.Full-enclosed splash guard		★	★	★	★
23.CTS full splash guard with top cover		★	★	★	★
24.Fluorescent x2/4/6		★	★	★	★
25.X/Y/Z-axis linear scale system_HEIDENHAIN		★	★	★	★
26.Manual x2/3		★	★	★	★
27.Hartford Manual x1/2/3		★	★	★	★
28.Hydraulic Hose Coolant gun		★	★	★	★
29.Air gun		★	★	★	★
30.Oil Fluid Separator		★	★	★	★
31.Hoist Seat		★	★	★	★
32.Maintenance safety guard(Including maintenance ladder)		★	★	★	★
33.X/Y-axis ball screw support device		★	★	★	★
34.Pedal Ladder		★	★	★	★
35.No bottom cover		★	★	★	★
36.Hybrid Spindle 10000RPM		★	★	★	★
37.ARM Type ATC		★	★	★	★
38.Coolant through spindle_Prepare		★	★	★	★
39.Coolant through spindle		★	★	★	★
40.TOUCH PROBE		★	★	★	★
41.Imitative Mold Cutting System		★	★	★	★
42.Closed Loop Linear Scale Positioning System		★	★	★	★
43.DNC Software		★	★	★	★

Electrical features Standard equipment & optional features

Hartrol / standard equipment

- Manual workpiece alignment
- Tool magazine graphics and data display
- Pop-up computer
- Supporting processing parameters
- Machine utilization rate analysis (only suitable for Fanuc)
- Internal and external thread cutting (only suitable for Fanuc)
- Tool magazine data display-Tool style graphical data display (only suitable for Fanuc)
- Tool life monitoring(only suitable for Fanuc)
- Lettering processing function
- Tool correction screen & fast tool change function((only suitable for Fanuc)

Hartnet / Optional features

- Whole plant utilization rate management system
- Processing countdown management
- Whole plant file transfer system
- Output management

Electrical function / Optional features

- Power-off gravity axis lift function
- Coordinate display hand input
- Tool magazine HMI
- Rigid tapping tool retraction
- Spindle thermal displacement compensation

item	Model	HSA-2212	HSA-X20	HSA-X23	HSA-X27	HSA-X28	HSA-X32	HSA-X36
1.Full-Enclosed Splash Guard _Multi-piece Door		●	●	●	●	●	●	●
2.Spindle Air Curtain		●	●	●	●	●	●	●
3.Air Blast Through Spindle		●	●	●	●	●	●	●
4.Table Side Air Blast (1 tube)		●	●	●	●	●	●	●
5.Lubrication system		●	●	●	●	●	●	●
6.Fluorescent lampx1		●	●	●	●	●	●	●
7.Spindle Cooler		●	●	●	●	●	●	●
8.Foundation bolt, Concrete		●	●	●	●	●	●	●
9.Portable Chip Bucket		●	●	●	●	●	●	●
10.Screw Type Chip Conveyor		●	●	●	●	●	●	●
11.Oil Fluid Separator		●	●	●	●	●	●	●
12.Cooling System		●	●	●	●	●	●	●
13.Tools package		●	●	●	●	●	●	●
14.Hartford Manual x1		●	●	●	●	●	●	●
15.Auto Power off		●	●	●	●	●	●	●
16.Operation Finish Lamp		●	●	●	●	●	●	●
17.Foot Switch For Spindle Clamp/Unclamp		●	●	●	●	●	●	●
18.Remote Manual Pulse Generator		●	●	●	●	●	●	●
19.RS232 Interface		●	●	●	●	●	●	●
20.Convection Heat Exchanger in Control Box		●	●	●	●	●	●	●
21.Armless Type Tool Magazine(20 pcs)		-	●	●	●	●	●	●
22.6000 rpm Gear Spindle		●	●	●	●	●	●	●
23.Semi-enclosed splash guard		-	★	★	★	★	★	★
24.CTS Full splash guard with top cover		★	★	★	★	★	★	★
25.Fluorescent Lamp x2		★	★	★	★	★	★	★
26.Link Type Chip Conveyor & Portable Chip Bucket(1 EA)		★	★	★	★	★	★	★
27.Coolant Through Spindle, 20BAR, with Secondary Tank		★	★	★	★	★	★	★
28.Coolant Through Spindle, 25BAR, with Secondary Tank		★	★	★	★	★	★	★
29.Hydraulic Hose Coolant gun		★	★	★	★	★	★	★
30.Air Gun		★	★	★	★	★	★	★
31.Hartford Manual x2/3		★	★	★	★	★	★	★
32.X/Y/Z-axis linear scale system_HEIDENHAIN		★	★	★	★	★	★	★
33.Without Tool Magazine		★	★	★	★	★	★	★
34.Tool ARM Type Tool Magazine		★	★	★	★	★	★	★
35.10000/12000 rpmDirect Drive Spindle		★	★	★	★	★	★	★
36.NC Rotary Table		★	★	★	★	★	★	★
37.Angular Head(HF-M90L)		★	★	★	★	★	★	★
38.Extend Head (Hartford)		★	★	★	★	★	★	★
39.Mutiangular Milling Head (HF-MU360L)		★	★	★	★	★	★	★
40.Semi-Automatic Angular Head ((HF-S90L)		★	★	★	★	★	★	★
41.Semi-Automatic Mutiangular Milling Head (HF-SU360L)		★	★	★	★	★	★	★
42.Automatic Angular Head(G.Y)		★	★	★	★	★	★	★
43.Extend Head (GY-E73N or GY-E75N)		★	★	★	★	★	★	★
44.Rotary ARM Seat of Angular Head		★	★	★	★	★	★	★
45.Auto Tool Length Measurement		★	★	★	★	★	★	★
46.Imitative Mold Cutting System		★	★	★	★	★	★	★
47.Speed Increaser		★	★	★	★	★	★	★
48.DNC Software		★	★	★	★	★	★	★