

GA SERIES

ULTRA PERFORMANCE CNC TURNING CENTERS



THE ULTIMATE MACHINING POWER
WOODWAY

ULTRA PERFORMANCE TURNING CENTERS

Engineered to handle heavy-duty turning applications with superb accuracy, the GA series ultra performance turning centers combine extremely powerful high torque motors, super rigid box way constructions, and large diameter servo indexing turrets to bring you The Ultimate Machining Power®. The GA series will help you be more competitive by achieving faster cycle times with heavier cuts, faster machine movements, and allow cutting of tough material efficiently. You'll also appreciate the reliability and durability that our machines are known for. Plus, with more standard features than any other machine on the market today, many say it's the best investment they have ever made.

- ▶ Extremely powerful high-torque spindles deliver 2.5 ~ 4 times the torque output of standard spindles.
- ▶ Extra large Z-axis servo motors provide the thrust needed to efficiently drill big diameter holes.
- ▶ In order to endure the machine's high outputs with durability, heavy-duty roller bearings are used to support the spindles and axes guide ways are of super-rigid one-piece box ways.
- ▶ The modern 30° slant wedge bed design provides smooth chip disposal and easier operator access without sacrificing machine rigidity.



(GA-2000 series model shown.)



(GA-3000 series model shown.)

GA series of all models (total 36 models)

SERIES	GA-2000 SERIES			GA-3000 SERIES		
Chuck Size	8"	8" / 10"	10"	10"	12"	15"
Bar Capacity	Ø 51 mm (2.0")	Ø 65 mm (2.5")	Ø 75 mm (2.9")	Ø 75 mm (2.9")	Ø 90 mm (3.5")	Ø 105 mm (4.0")
Turning Length	300 mm*1	GA-2000/300 / 300M	GA-2600/300 / 300M	GA-2800/300 / 300M	—	—
	600 mm*1	GA-2000 / M	GA-2600 / M	GA-2800 / M	GA-3000 / M	GA-3300 / M
	900 mm*1	—	—	—	GA-3000/900 / 900M	GA-3300/900 / 900M
	1,200 mm*1	GA-2000L / LM	GA-2600L / LM	GA-2800L / LM	GA-3000L / LM	GA-3300L / LM

/300 : Compact Bed /900 & L : Long Bed M : Live Tooling & C-axis

*1 Turning length listed here are approximate numbers, individual models may vary. Please see machine specifications page for details.

GA series machines (excluding compact bed GA-2000/300 model) feature a standard programmable base and quill tailstock.

- ▶ Manual mode quill-jog function allows the quill to be inched forward, which makes it easier to insert the center into the center hole.
- ▶ Movement of the base and quill in auto mode are controlled by M-codes and thrust pressure is manually adjustable.
- ▶ Z-axis carriage automatically locks onto the tailstock base and moves it to the desired position with precision accuracy.



Tailstock shown with optional live center

Machine rigidity is increased by eliminating the opening required for under-machine-type coolant tanks.

- ▶ Utilizing unused space, this larger 145 L coolant tank placement allows optimal air circulation for faster heat dispersion and lower coolant temperature, which will help extend coolant life.
- ▶ Heat escapes directly into the air, not trapped inside the machine; this tremendously improves the machine's overall accuracy by lowering thermal expansion effects to a minimum.
- ▶ Coolant tank allows the connection of compressed air to circulate coolant and keep it fresh when machine is not in use.

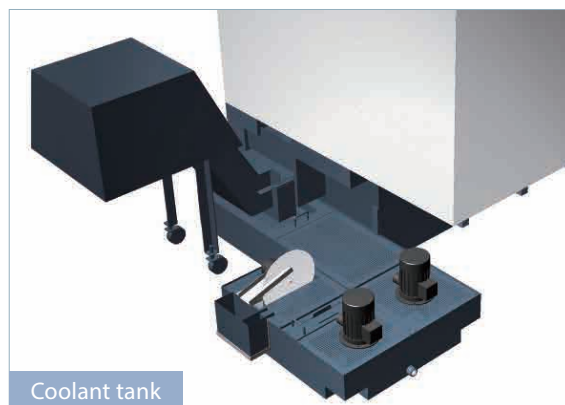

Coolant tank



(GA-3300L model shown.)

GA-2000/300 COMPACT DESIGN SERIES

- ▶ By using the same high rigidity design, GA-2000/300 series only needs 3.3 m² floor space which makes much more flexible for space usage.
- ▶ Back-exit conveyor design is suitable for central conveyor gathering arrangement which can efficiently lower manpower.

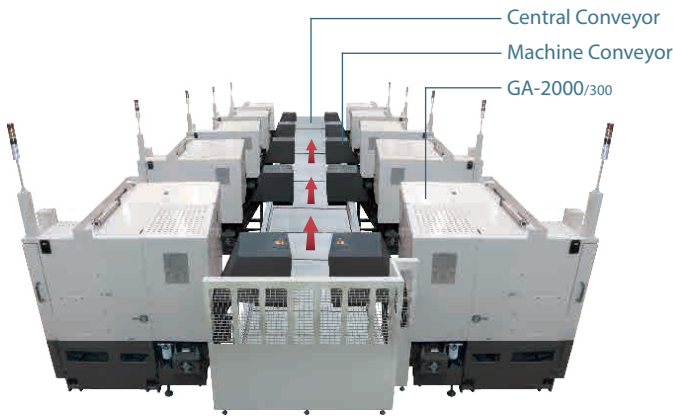

(GA-2000/300 model shown.)

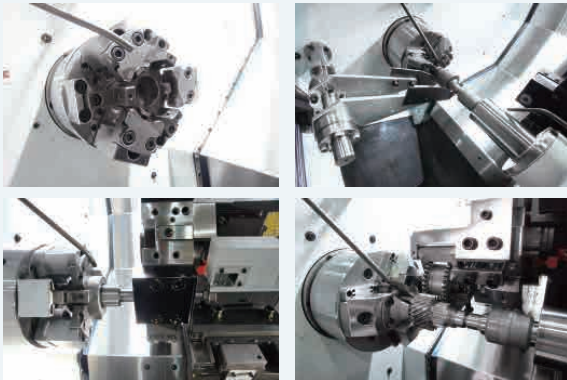

Customized Equipment

Integrated the characteristics of GA-2000/300 and great engineering, GOODWAY is capable to develop all sort of specialized and customized equipment for customers. GOODWAY is selected by well-known automobile corporations.

Robot Arm

Featured robotic arm, loading and unloading can be done in one setup which is pretty safe and quick to fulfill needs of mass production.



(Robotic arm)



(Gantry type robotic arm)

HIGH RIGIDITY STRUCTURE

- ▶ By using Finite Element Methods (FEM), optimal reinforce ribbings are directly cast into the one-piece bed structure. Mechanical rigidity has been increased by more than 30% when compared to conventional designs.
- ▶ Built to withstand years and years of rigorous high production turning, the heavily ribbed, one-piece thermally balanced bed and casting components are of " MEEHANITE " casting.
- ▶ X and Z axes are driven by over-sized FANUC AC α i series absolute servo motors, providing tremendous thrust outputs with faster acceleration and deceleration. Absolute encoder technology eliminates the use of limit switches, thus, eliminating referencing axes to home positions and broken limit switches.

- ▶ Extra wide, hardened and precision ground box ways are widely space, and directly cast on to the machine bed and saddle for maximum strength and precision. The box way design also provides the rigidity needed for heavy-duty and interrupted turning applications.
- ▶ C3 class hardened and precision ground ball screws ensure the highest accuracy and durability possible. Plus, pretension on all axes minimizes thermal distortion.
- ▶ Slide ways are bonded with " Turcite B " to eliminate stick-slip, minimize wear and maintain long term accuracy. Rapids are 20 m/min. on X-axis & 24 m/min. on Z-axis.

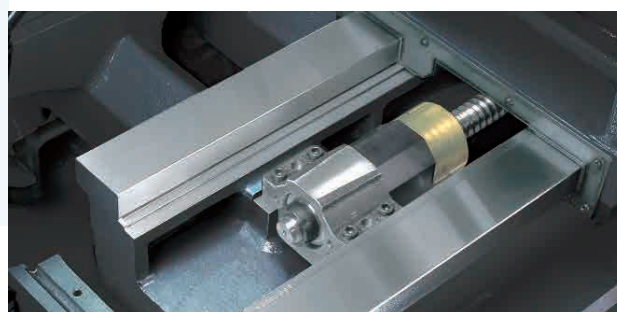
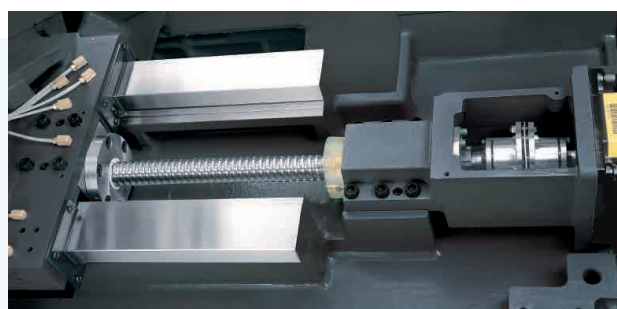

Contact surfaces of all slides, headstock, turret, tailstock, and ball screw bearing housings with the machine bed are hand scraped to provide maximum assembly precision, structural rigidity, and load distribution.

ULTIMATE TURNING POWER

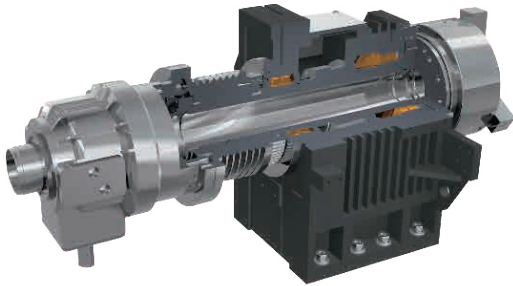

- ▶ P4 grade (Class 7) super-high precision bearings are directly assembled for maximum level of support and precision. Bearing configuration is designed for super heavy-duty cutting with ultra-smooth performance and long term durability with a higher level of accuracy.
- ▶ The optional 2-step gear box provides maximum torque up to 1,040 Nm (GA-3600), which can easily meet with heavy cutting requirements.

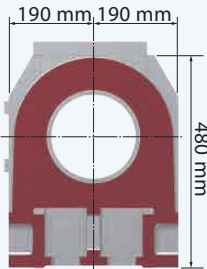

Head stocks feature even thickness sides, which evenly distribute cutting forces to the machine bed, resulting in exceptional vibration dampening characteristics and forms a stronger structure to handle interrupted and heavy cutting applications.

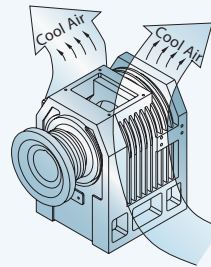

Heat dispending fins around the headstock evenly dispense heat to reduce deformation, therefore, increasing machining accuracy.

GA-2000 Series Spindle Output

High-Speed (Δ Connection) Spindle Output

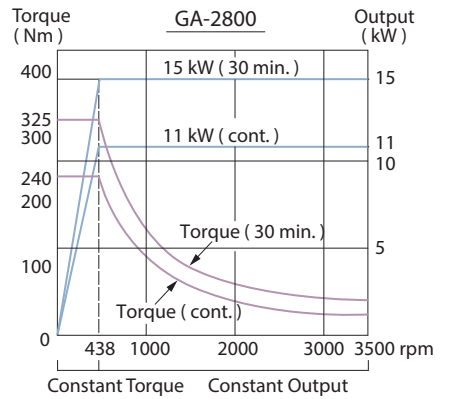
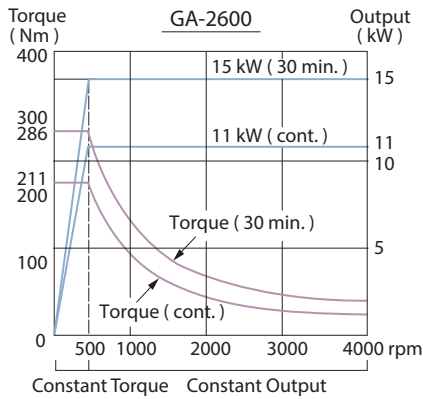
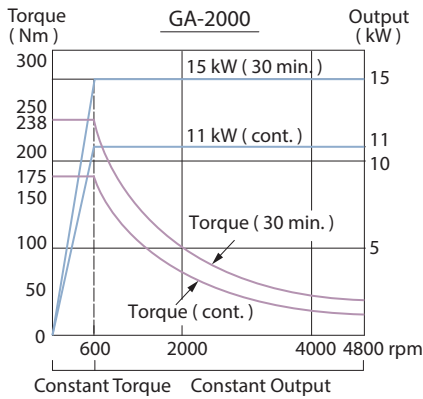

Low-Speed (Y Connection) Spindle Output

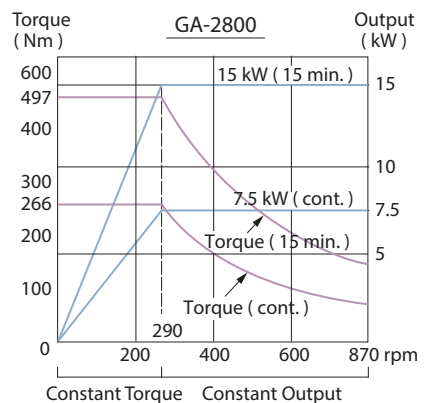
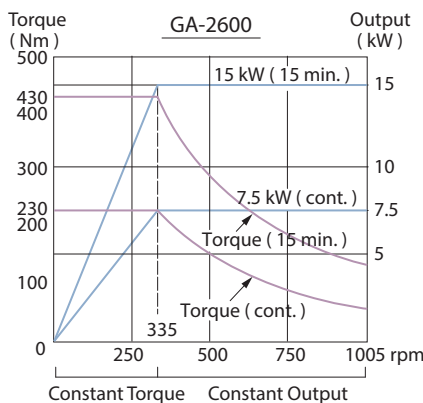
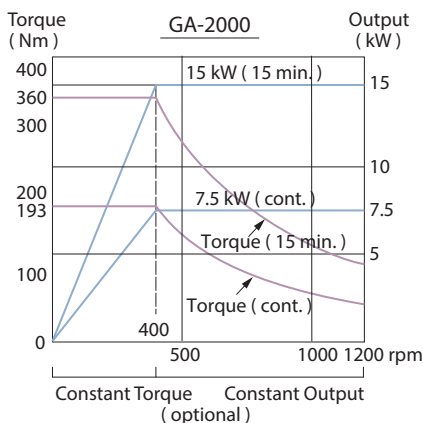

GA-3000 Series Standard Spindle Output

High-Speed (Δ connection) Spindle Output

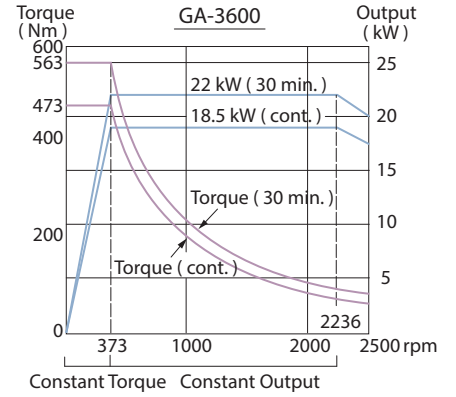
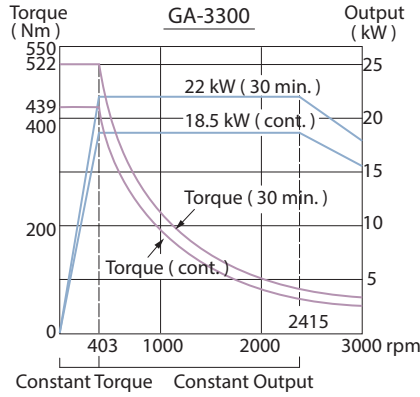
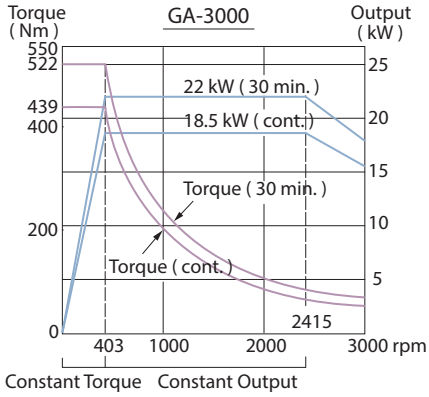

Low-Speed (Y connection) Spindle Output

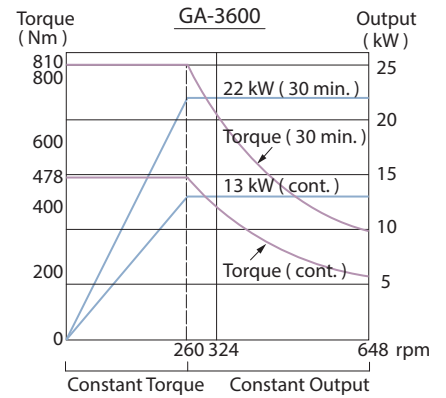
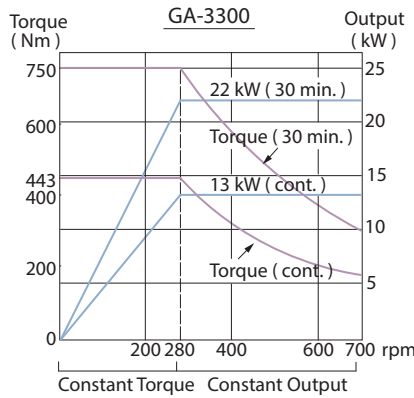
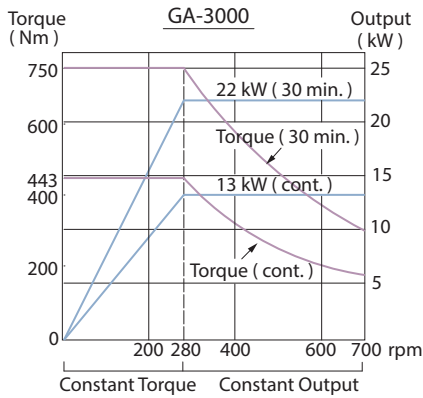

GA-3000 Series Optional Gear Box Spindle Output

High Gear

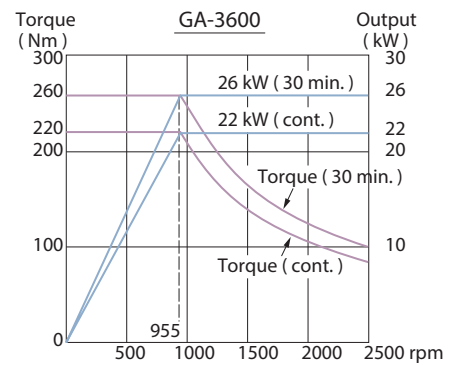
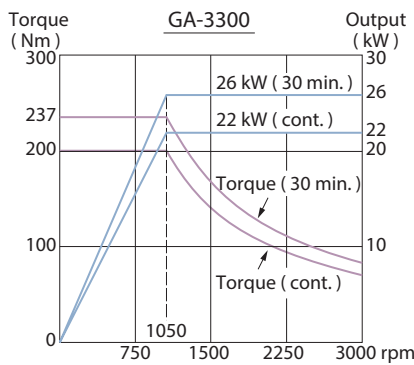
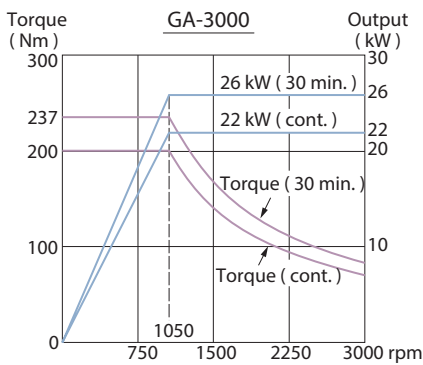

Low Gear

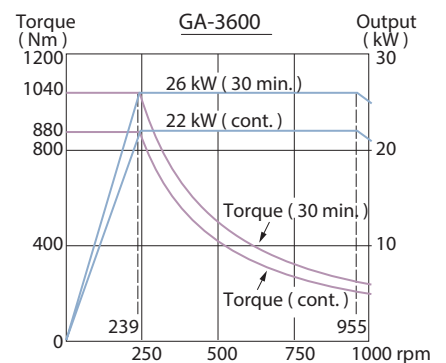
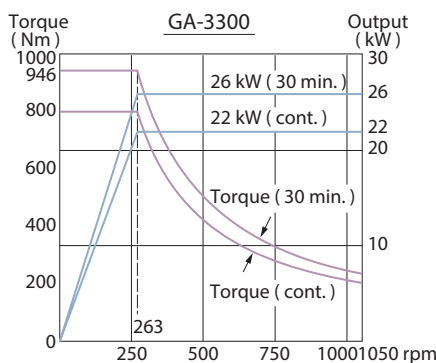
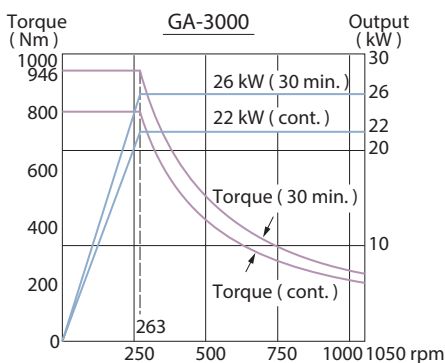

ADVANCED TURRET TECHNOLOGY

GA-2000 Series

- ▶ The heavy-duty servo indexing turret achieves 0.2 second indexing times for adjacent stations and 0.5 second for stations at the opposite end of the disk. Index movements are single step, without pauses, no matter how many stations are skipped.
- ▶ \varnothing 230 mm diameter super high precision curvic couplings accurately position the turret disk and 4,700 kg of clamping force ensures abundant turret rigidity for all cutting conditions.

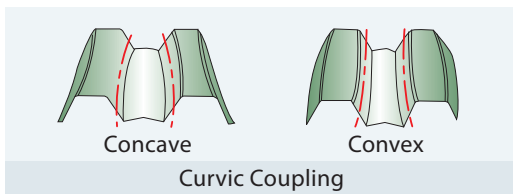

- ▶ The standard 12-station turret clears 8" diameter work holding devices without interference, even when loaded with tooling at maximum shank size. The optional 10-station turret clears 10" diameter work holding devices without interference, even when loaded with tooling at maximum shank size.



[Standard 12-Station Turret]

Tooling System

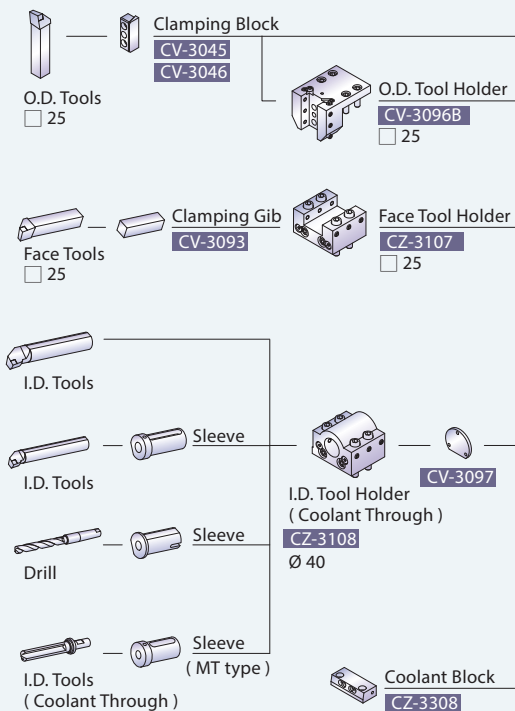

Interference Diagram

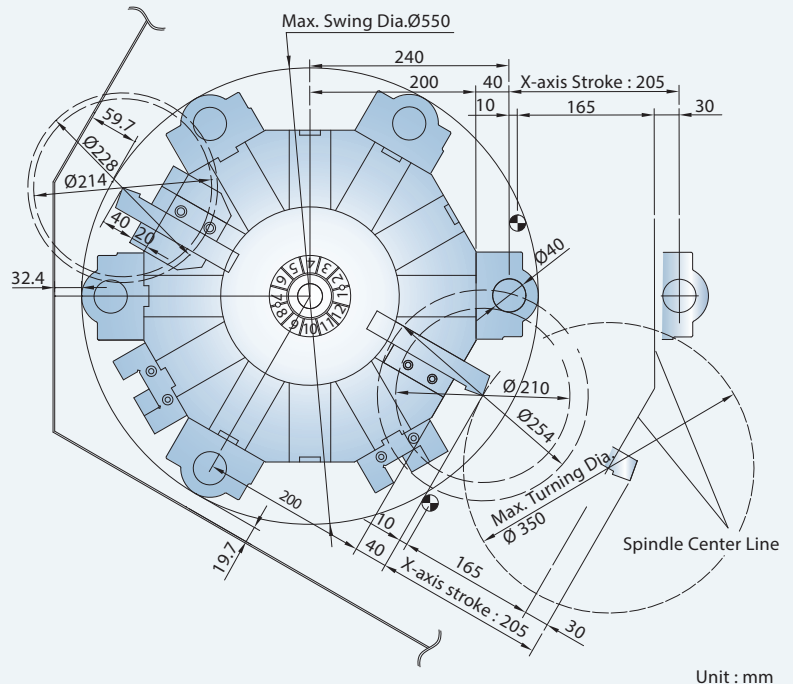

Work Range

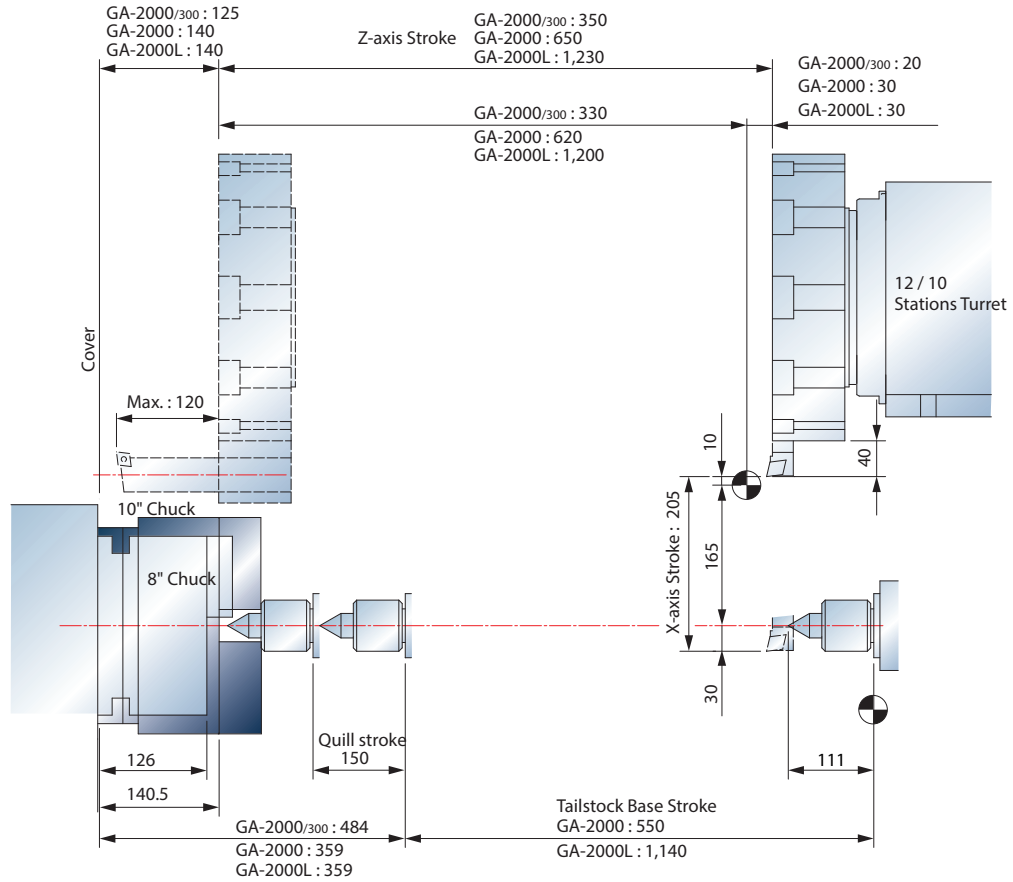

[Optional 10-Stations Turret]

Tooling System

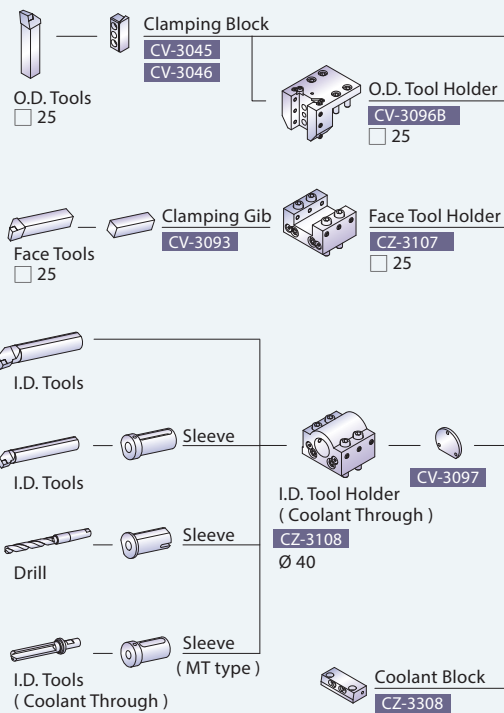

Interference Diagram

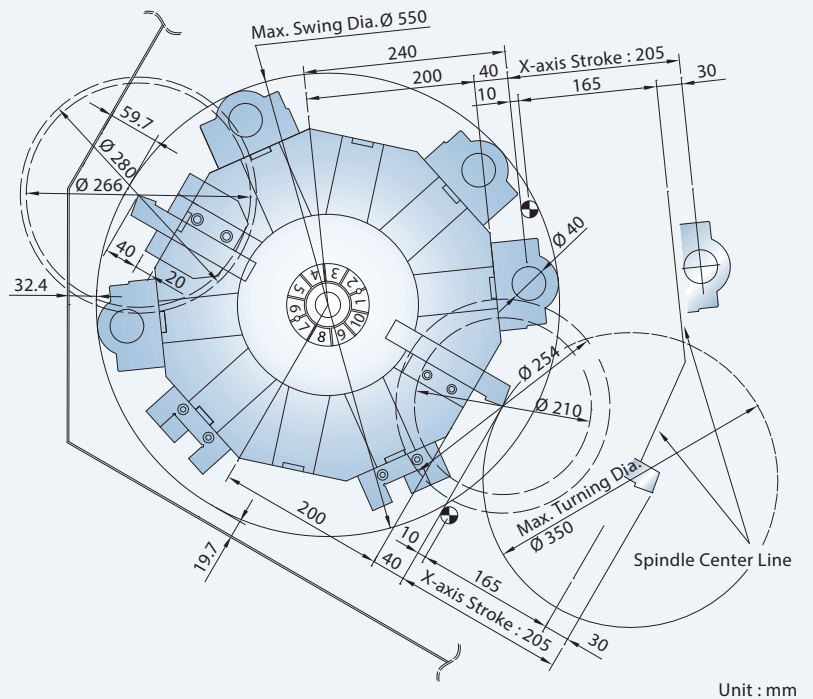

ADVANCED TURRET TECHNOLOGY

GA-3000 Series

- ▶ The heavy-duty servo indexing turret achieves 0.2 second indexing times for adjacent stations and 0.5 second for stations at the opposite end of the disk. Index movements are single step, without pauses, no matter how many stations are skipped.
- ▶ \varnothing 250 mm diameter super high precision curvic couplings accurately position the turret disk and 5,200 kg of clamping force ensures abundant turret rigidity for all cutting conditions.

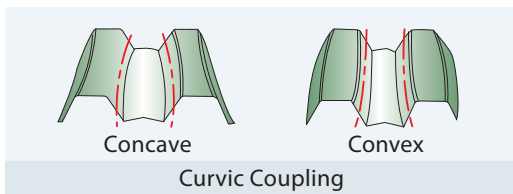

- ▶ The standard 12-station turret clears 8" diameter work pieces without interference, even when loaded with tooling at maximum shank size. The optional 10-station turret clears 10" diameter work pieces without interference, even when loaded with tooling at maximum shank size.



[Standard 12-Station Turret]

Tooling System

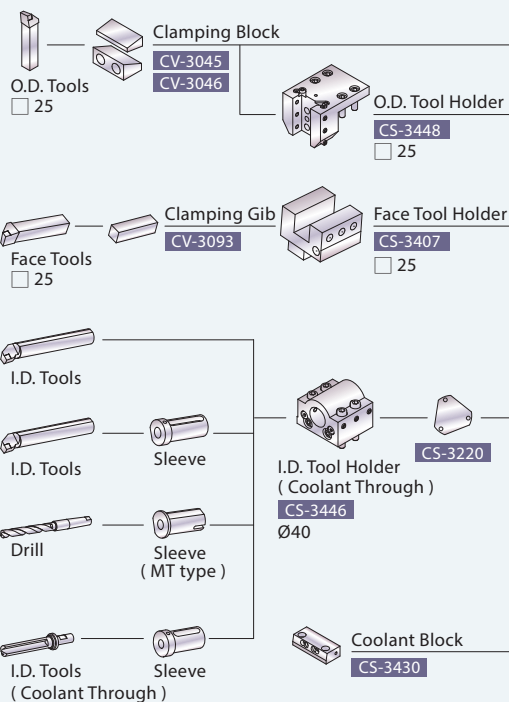

Interference Diagram

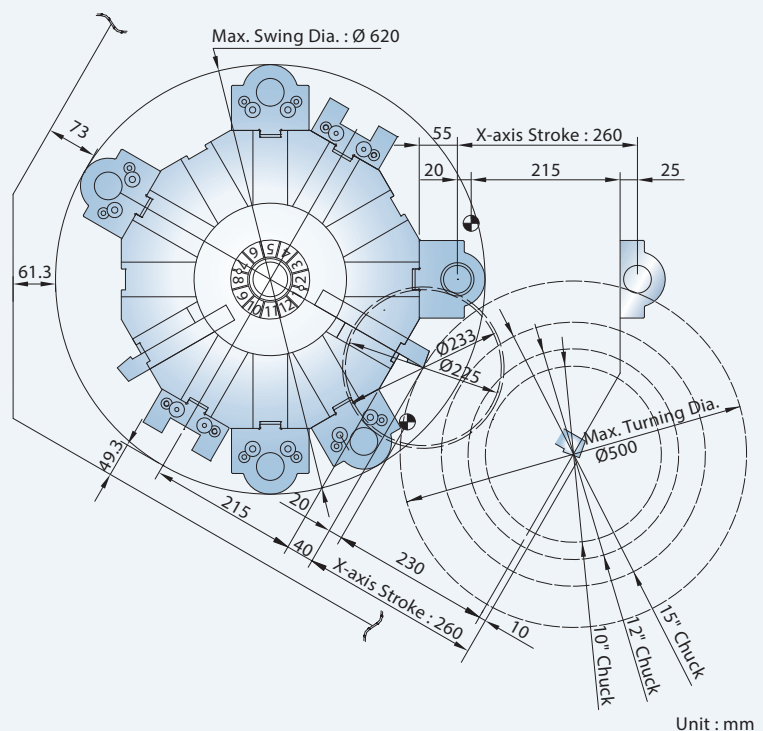

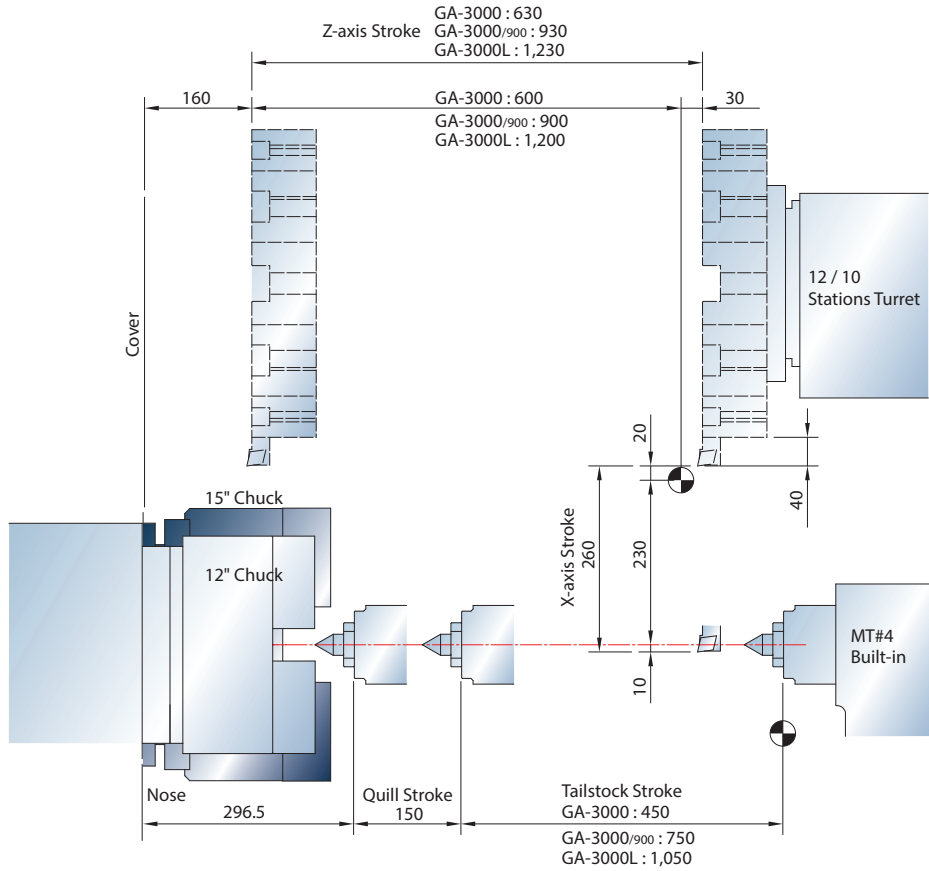

[Optional 10-Stations Turret]

Tooling System

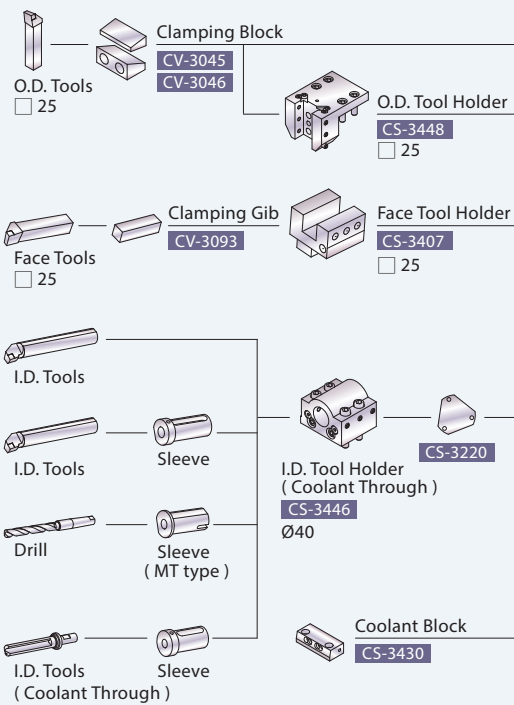

Interference Diagram

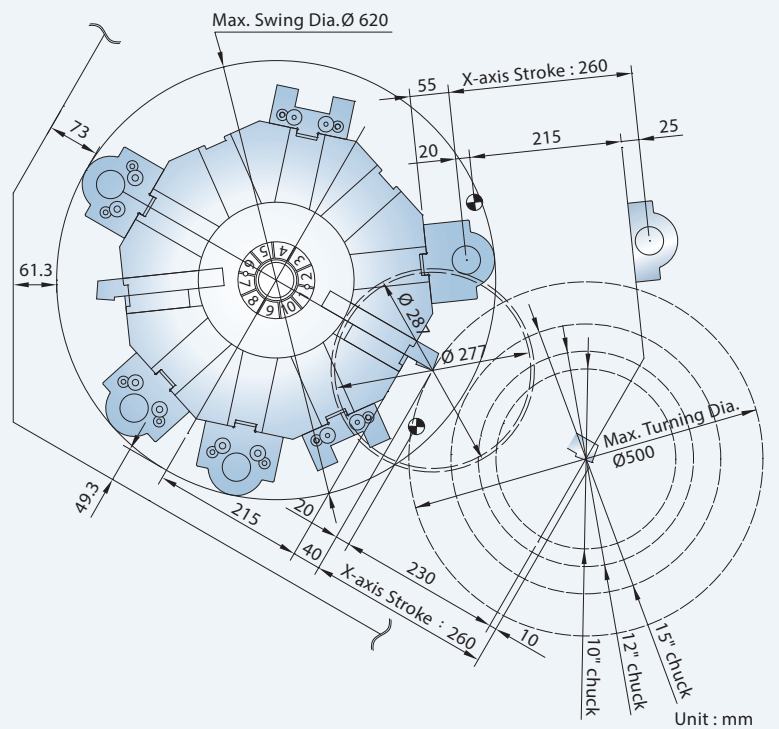

LIVE TOOLING TURRETS

- ▶ Live tooling capabilities on the GA series allows a work-piece to be turned, milled, drilled and tapped without moving it to another machine.
- ▶ The 12-station GOODWAY live tooling turret offers 12 stations available for live tooling (live tooling tools rotate in working position only) and features a non-lifting turret disk.
- ▶ GOODWAY's live tooling turret utilizes the latest servo indexing technology to achieve 0.2 second indexing times for adjacent stations and 0.5 second for stations at the opposite end of the disk.
- ▶ With the latest technology, live tooling is driven by an AC servo motor to provide ample power, in the form of torque. Now, even the toughest of jobs may be tackled without a sweat.

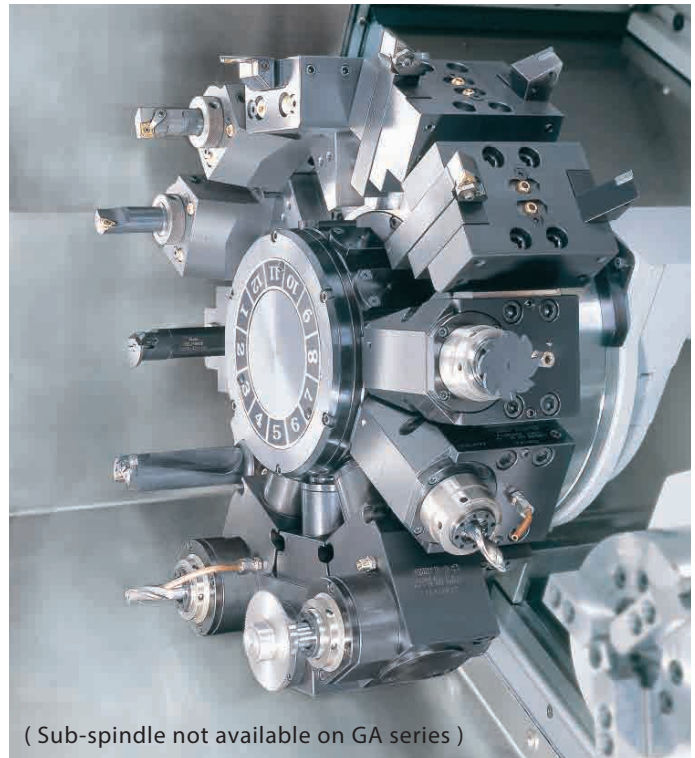

(Sub-spindle not available on GA series)

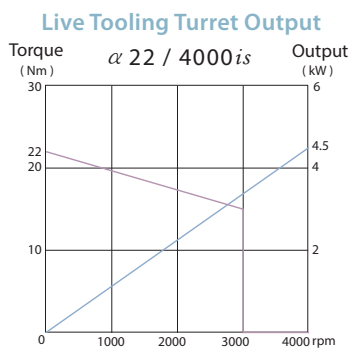

4.5 kW
Drive Motor Power
(cont.)

16 mm
Max. Tapping
Capacity

Ø20 mm
Max. Milling
Capacity

4 : 3
Gear Ratio

ULTIMATE C-AXIS SPINDLE

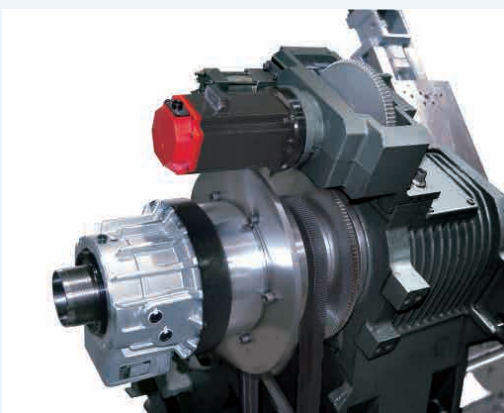

- ▶ With the FANUC servo motor generating an ultra high resolution of 33,000,000 pulses per spindle rotation and 480 Nm of torque, surface finishes are much superior than Cs-axis (driven by spindle motor) equipped machines. Plus, dynamic accuracy is within $\pm 0.02^\circ$ even under heavy cutting loads.

- ▶ The Cf-axis and disk brake system available on the GA series provides the most rigid and powerful type of C-axis on the market today. In Cf-axis mode, a servo motor is engaged and drives the rotation of the spindle, engagement time is less than 2 seconds.
- ▶ Working with the live tooling turret, the Cf-axis and disk brake system enables the machine to perform drilling, tapping, and milling operations, including cylindrical and polar coordinate interpolations (resembling a 4th-axis rotary table on a machining center).

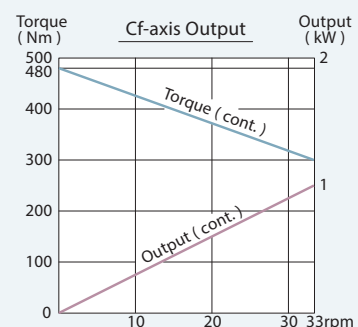

LIVE TOOLING & SPECIAL TOOL HOLDERS

0° Live Tool Holder

O.D. drill & mill holder

- ER 32 collet



O.D. mill holder with combination mill arbor similar to DIN 6358



High speed O.D. drill & mill holder

- ER 20 collet
- Max. 8,000 rpm, ratio i = 1 : 2



90° Live Tool Holder

Face drill & mill holder

- ER 32 collet



Dual-side face drill & mill holder

- ER 32 collet



High speed face drill & mill holder

- ER 32 collet
- Max. 8,000 rpm, ratio i = 1 : 2



Dual-Face Turning Holder

GOODWAY dual-face turning holder allow both sides of a disk-type work-piece to be machined at the same time. Tool holder automatically spreads open for retracting tooling to avoid damage to the turned surfaces.



Simultaneous dual-face turning of disk brake



Fine adjustment of turning thickness

- ▶ Machining time is reduced by over 50%.
- ▶ Excellent surface quality by using a viper geometry ground insert.
- ▶ The angle of blades have been adjusted precisely to obtain the optimal surface accuracy of work-piece.
- ▶ Reduced vibration & increase parallelism accuracy utilizing symmetrical cutting pressure.

- ▶ Activating the live tool holder can be done by slightly adjust scale ring, in order to quickly and precisely adjust the thickness of cutting.
- ▶ Setups are easy with the integration of both hydraulic and spring activation.

[12-Station Live Tooling Turret]

GA-2000 Series Work Range

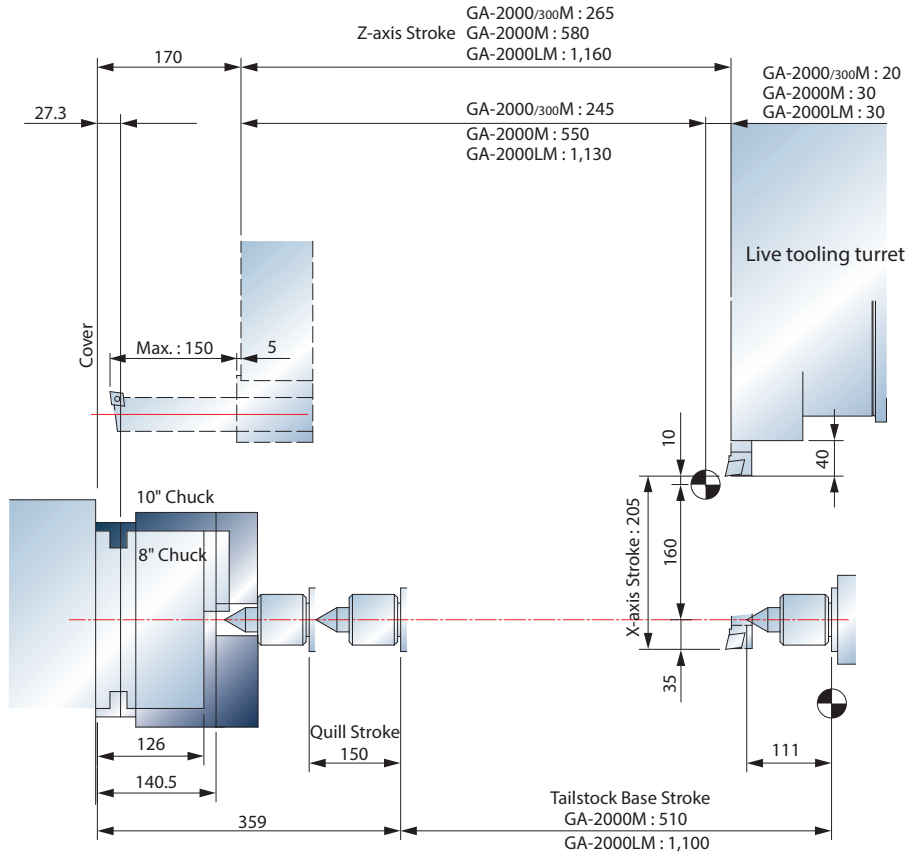

Tooling System

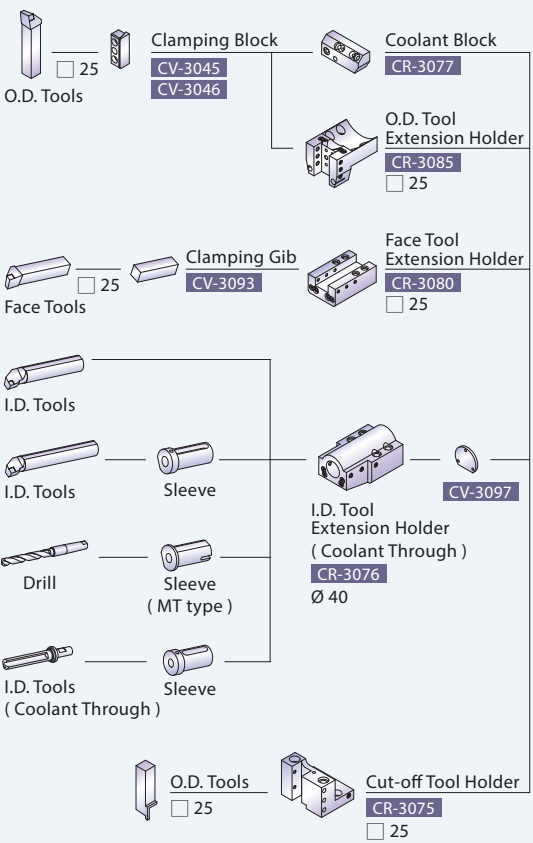

Interference Diagram

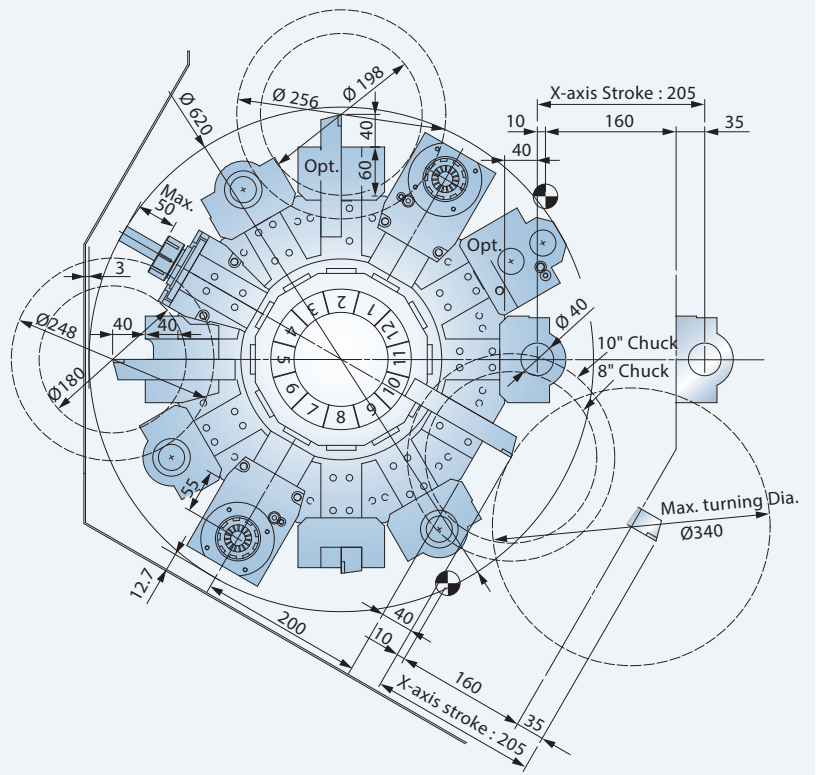

Unit : mm

[12-Station Live Tooling Turret]

GA-3000 Series Work Range

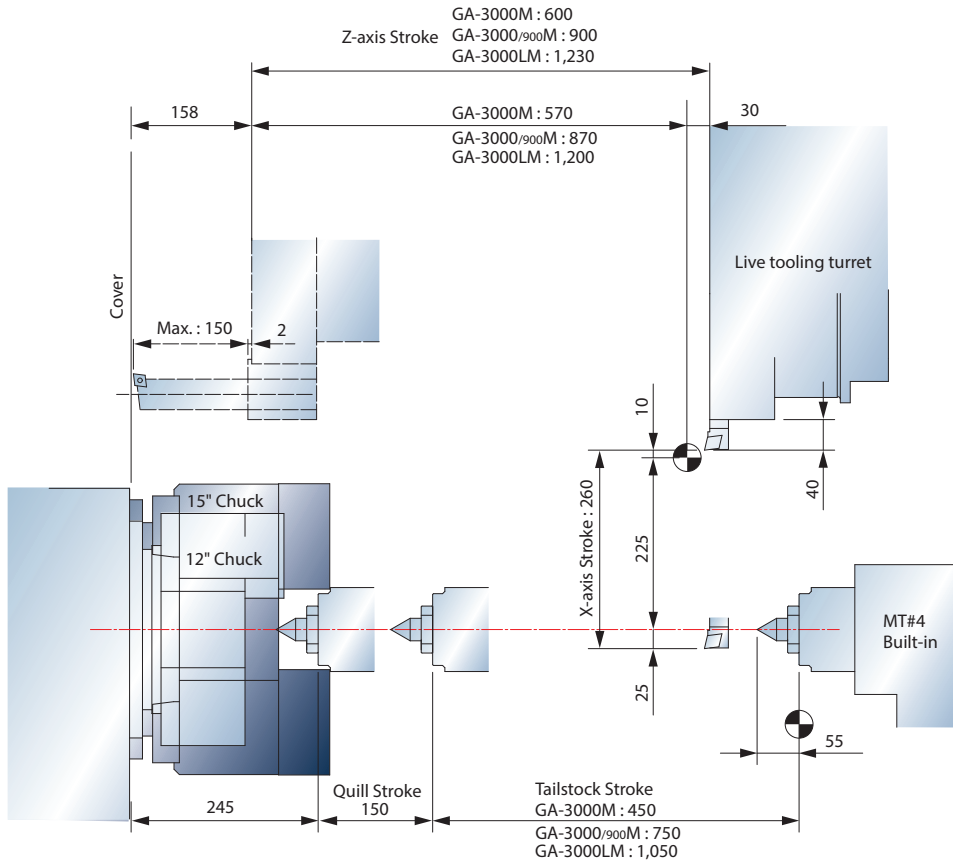

Tooling System

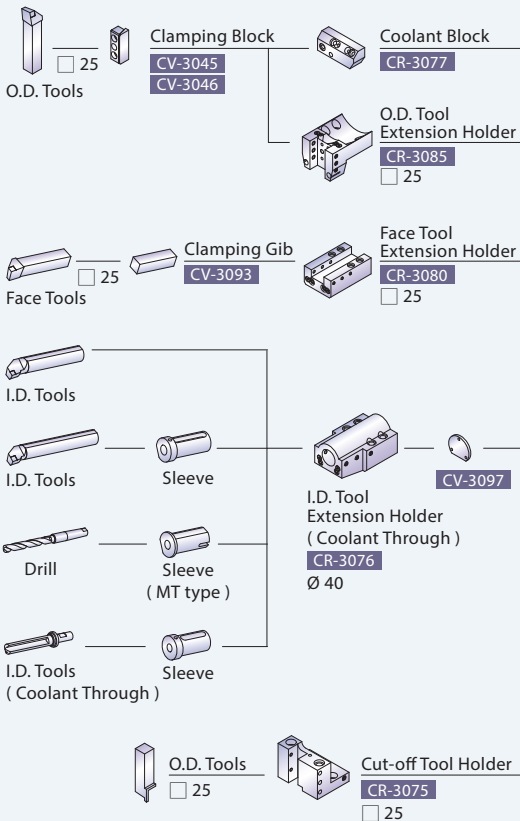

Interference Diagram

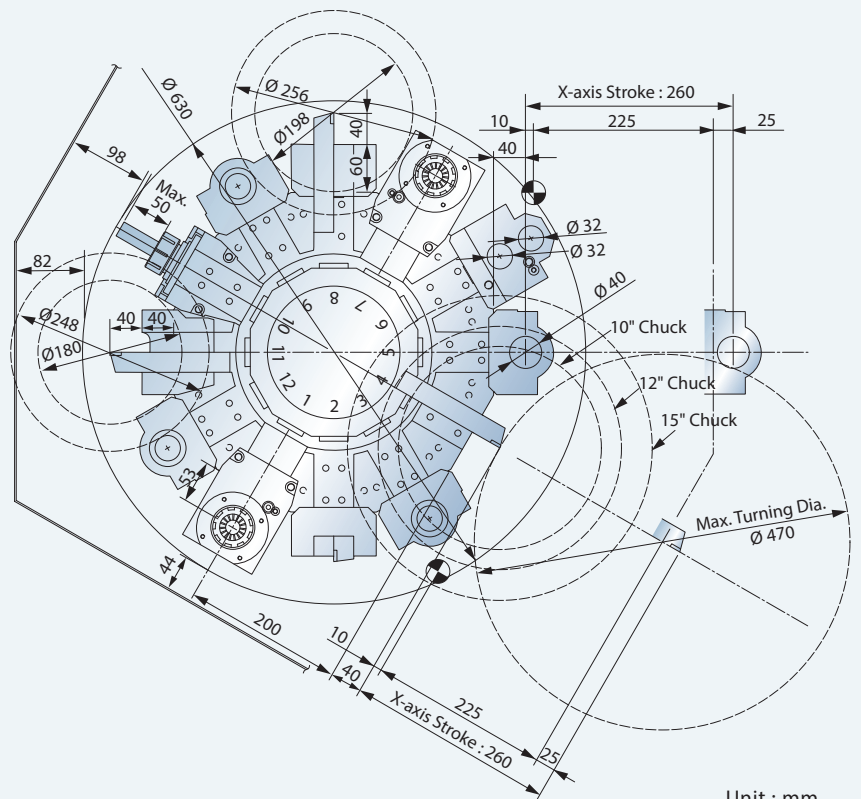

MACHINING PERFORMANCE

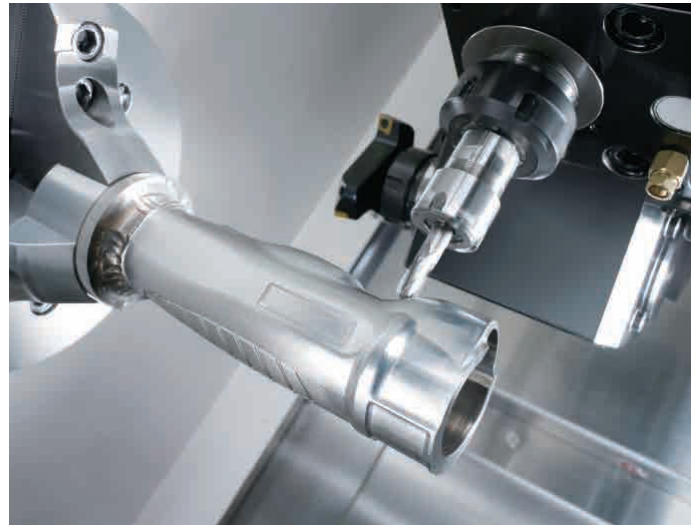
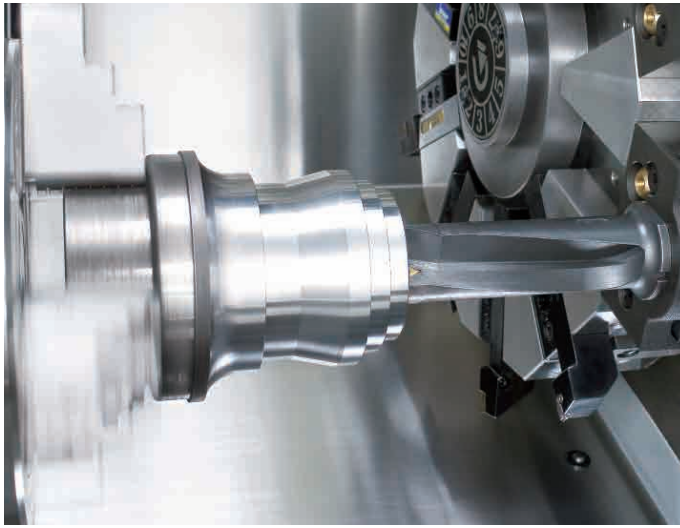

O.D. Heavy Cutting Example

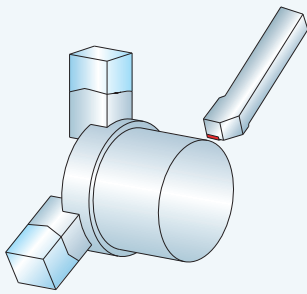

	O.D. Before Cut	O.D. After Cut	Spindle Speed	F / Rev.	Depth of Cut (side)	Spindle Load
GA-2000	108 mm	96 mm	500 rpm	0.30 mm	6 mm	97%
	96 mm	82 mm	550 rpm	0.32 mm	7mm	112 %
GA-3000	144 mm	120 mm	729 rpm	0.40 mm	12 mm	65%

Machining Capability

Material : S45C

	Models	Tools (mm)	Spindle Speed (rpm)	Cutting Speed (m/min)	Feedrate (mm/min)	Cutting Depth (mm)
Drill		Ø 20	600	38	60	N/A
End Mill	GA-2000 GA-3000	Ø 20	1,000	63	200	12.7
Tapping		M16 * P2.0	200	10	400	N/A

GA-2000 Spindle Acc. / Dec. Times
Chuck : 10" + Hard Jaws

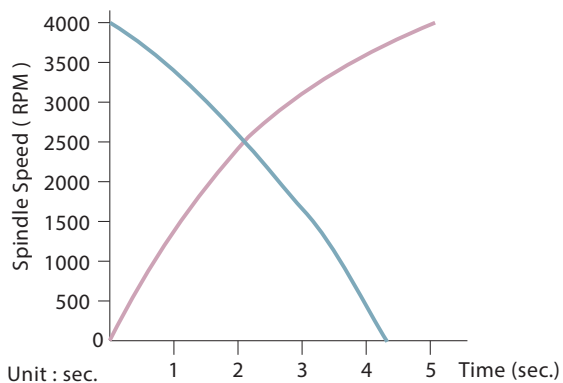

	RPM	500	1000	1500	2000	2500	3000	3500	4000
— Acc.		0.7	1.3	1.7	2.3	3.0	3.6	5.0	6.4
— Dec.		0.5	0.8	1.3	1.8	2.5	3.1	4.0	4.8

GA-3000 Spindle Acc. / Dec. Times
Chuck : 12" + Hard Jaws

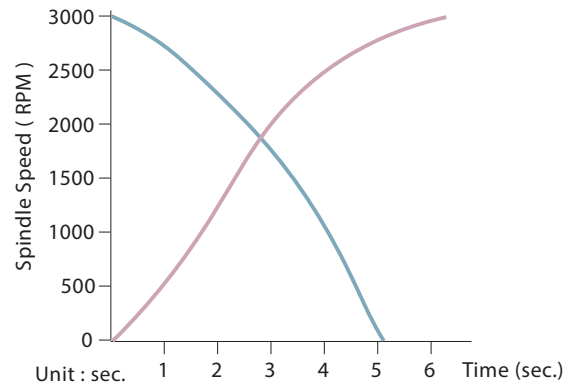

	RPM	500	1000	1500	2000	2500	3000
— Acc.		0.9	1.7	2.4	3.0	4.2	6.4
— Dec.		0.9	1.8	2.6	3.2	4.0	5.1

GENERAL DIMENSION

Space Requirement

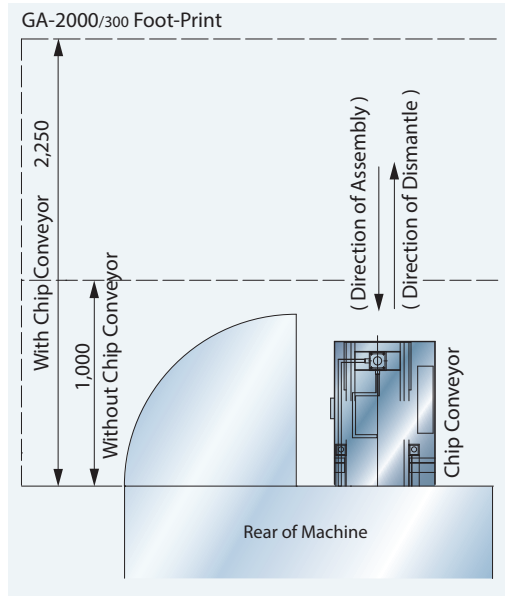
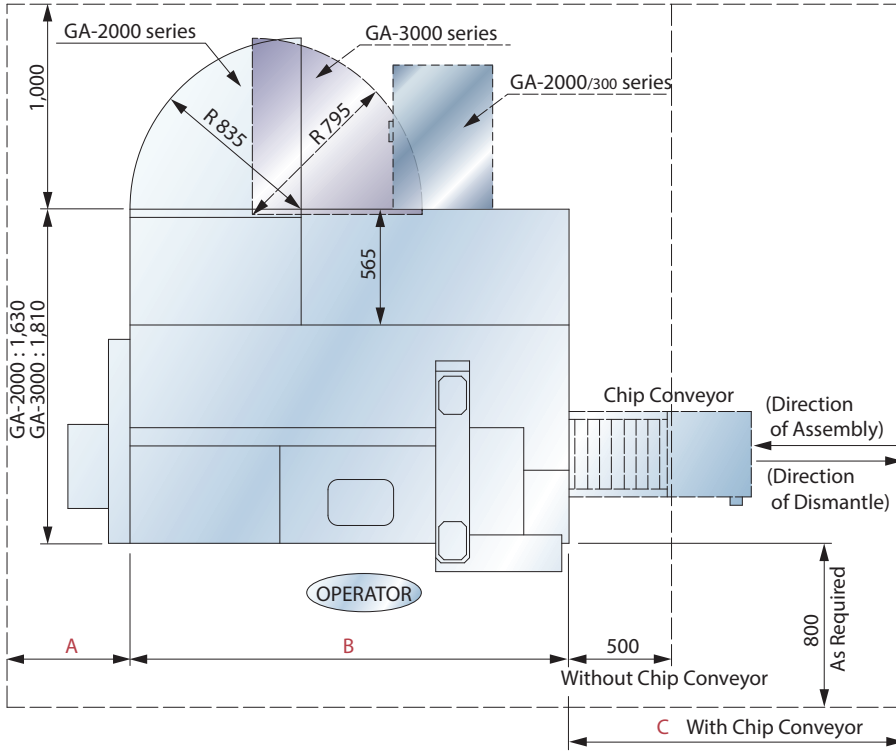

Model	A	B	C
GA-2000/300	500	1,812	2,250
GA-2000	600	2,142	2,300
GA-2000L	600	3,242	2,850
GA-3000	500	2,742	2,400
GA-3000/900	500	3,062	2,900
GA-3000L	500	3,392	3,300

Unit : mm

Machine Layout

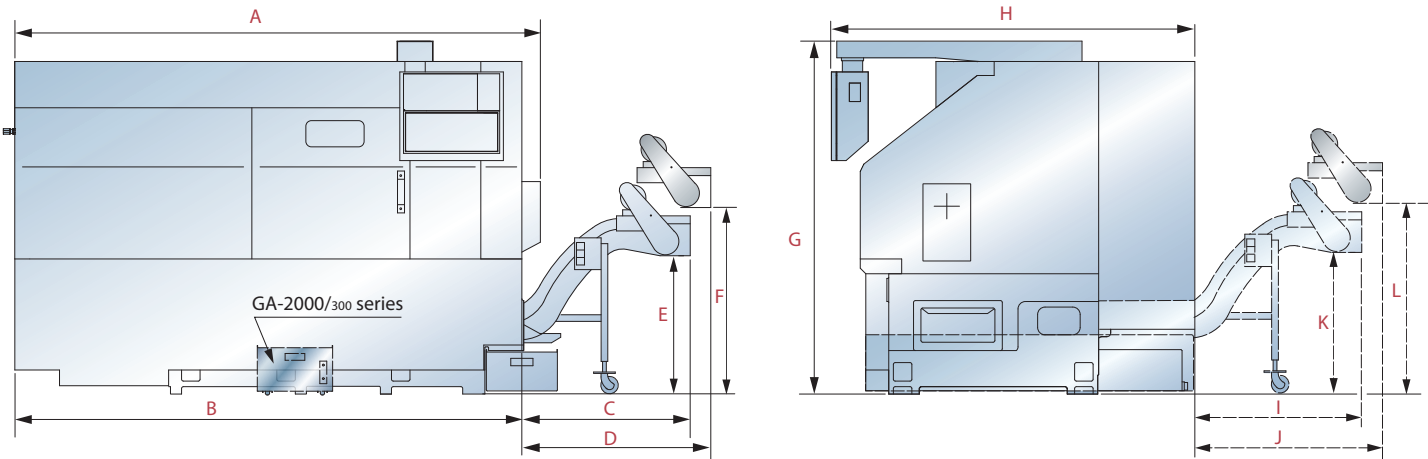

Model	A	B	C	D	E	F	G	H	I	J	K	L
GA-2000/300	2,014	1,812	-	-	-	-	1,725	1,630	730	1,055	843	1,232
GA-2000	2,445	2,142	984	1,245	685	1,205	1,890	1,630	875	765	705	1,206
GA-2000L	3,345	3,242	870	1,145	745	1,221	1,845	1,630	-	-	-	-
GA-3000	2,845	2,742	995	1,280	680	1,243	1,910	1,965	825	-	680	-
GA-3000/900	3,165	3,062	1,095	1,280	690	1,243	1,910	1,980	-	-	-	-
GA-3000L	3,642	3,392	995	1,258	656	1,209	1,910	1,965	-	-	-	-

Specifications are subject to change without notice.

Unit : mm

STANDARD & OPTIONAL FEATURES



Chip Conveyor

The standard chip conveyor features adjustable timers that allow the operator to set operation intervals according to the amount of chips generated by the machine. Thus, reducing coolant loss to a minimum.

Models	Type	Hinge	Scraper	Magnet scraper
GA-2000/300	Right	-	-	-
	Rear	S	O	O
GA-2000 GA-3000	Right	S	O	O
	Rear	O	O	O
GA-2000L GA-3000/900 GA-3000L	Right	S	O	O
	Rear	-	-	-

S : Standard O : Option - : Not Available

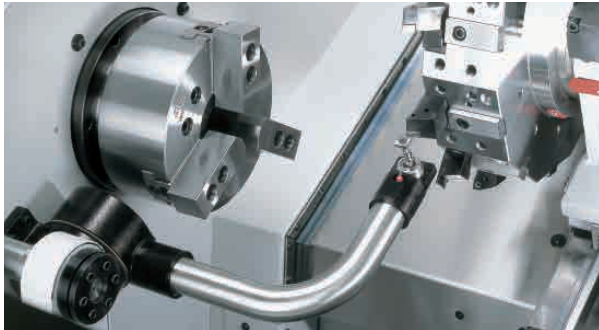

Tool Setter (Opt.)

The optional RENISHAW HPM-A tool setter utilizes a motorized arm to lower the tool probe into position. An auto tool check function further increases tool touch off efficiency. (HPR-A removeable-arm type tool setter on GA-3600 / L series)



Load Monitoring (Opt.)

The load monitoring function is used to detect abnormal load of tools by monitoring the variation in spindle motor and servo motor loads during the cutting process. When abnormal loads are detected, the machine will stop at program end (M30) or immediately (feed hold status) according to tool life value or tool break value respectively.



Parts Catcher (Opt.)

Optional hydraulic parts catchers can be programmed to catch finished parts after cut-off.



Bar Feeder (Opt.)

Optional bar feeding systems feed bars up to Ø 65 mm diameter.

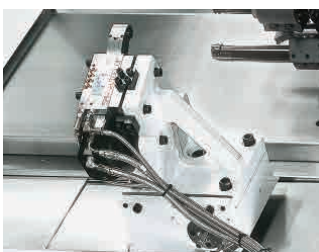

Automatic Steady Rest (Opt.)



Parts Conveyor (Opt.)



4-Jaw Chuck (Opt.)



Air Chuck (Opt.)

S : Standard O : Option
 - : Not Available C : Contact GOODWAY

		GA-2000	GA-2600	GA-2800	GA-3000	GA-3300	GA-3600
SPINDLE							
Main spindle motor configuration	Single-speed	S	S	S	S	S	S
	Two-speed	O	O	O	O	O	O
Rigid tapping & spindle orientation		S	S	S	S	S	S
Spindle disk brake		O	O	O	O	O	O
Cf-axis & spindle disk brake*1		O	O	O	O	O	O
WORK HOLDING							
Hydraulic hollow 3-jaw chuck	8"	S	-	-	-	-	-
	8" Big-Bore	-	O	-	-	-	-
	10"	-	S	S	S	-	-
	10" Big-Bore	-	-	O	-	-	-
	12"	-	-	-	-	S	-
Hard jaws	1 set	O	O	O	O	O	O
	Soft jaws	S	S	S	S	S	S
Collet chuck		O	O	O	O	O	O
Special work holding chuck		C	C	C	C	C	C
In spindle work stopper		O	O	O	O	O	O
Spindle liner (guide bushing)		O	O	O	O	O	O
Foot switch for chuck operation	Single	S	S	S	S	S	S
	Double	O	O	O	O	O	O
Programmable base & quill hydraulic tailstock		S	S	S	S	S	S
MT#4 live center		O	O	O	-	-	-
MT#5 live center		-	-	-	O	O	O
Foot switch for tailstock operation	Single	O	O	O	O	O	O
	Double	O	O	O	O	O	O
Self-centering hydraulic steady rest		O	O	O	O	O	O
Foot switch for steady rest operation		O	O	O	O	O	O
Two-stage programmable pressure	Chuck clamping	O	O	O	O	O	O
	Tailstock thrust	O	O	O	O	O	O
TURRET							
10-station turret		S	S	S	S	S	S
12-station turret		O	O	O	O	O	O
12-station live tooling turret w/ no-lift tooling disk*1		O	O	O	O	O	O
Tool holder & sleeve package		S	S	S	S	S	S
Live tooling tool holders		O	O	O	O	O	O
MEASUREMENT							
RENISHAW HPMA tool presetter	Motorized arm	O	O	O	O	O	-
RENISHAW HPRO tool presetter		-	-	-	-	-	O
COOLANT							
Coolant pump	3 kg/cm ²	S	S	S	S	S	S
	5 kg/cm ²	O	O	O	O	O	O
High-pressure coolant system	20 kg/cm ²	O	O	O	O	O	O
Roll-out coolant tank		S	S	S	S	S	S
Oil skimmer		O	O	O	O	O	O
Coolant flow switch		O	O	O	O	O	O
Coolant level switch		O	O	O	O	O	O
Coolant intercooler system		O	O	O	O	O	O
CHIP DISPOSAL							
Chip conveyor with auto timer	Right discharge	S	S	S	S	S	S
	Rear discharge*2	O	O	O	O	O	O
Chip cart with coolant drain		O	O	O	O	O	O
Chuck air blow		O	O	O	O	O	O
Tailstock air blow		O	O	O	O	O	O
Coolant gun		O	O	O	O	O	O
Oil mist collector		O	O	O	O	O	O
AUTOMATIC OPERATION SUPPORT							
Parts catcher		O	O	O	O	O	O
Work-piece transport conveyor		O	O	O	O	O	O
Bar feeder		O	O	O	O	O	O
Bar feeder interface		O	O	O	O	O	O
Gantry-type loader / unloader		O	O	O	O	O	O
Auto door		O	O	O	O	O	O
Extra M-code output	4 sets (8)	O	O	O	O	O	O
	8 sets (16)	O	O	O	O	O	O
SAFETY							
Fully enclosed guarding		S	S	S	S	S	S
Door interlock (incl. Mechanical lock)		S	S	S	S	S	S
Tailstock stroke out-end check		S	S	S	S	S	S
Chuck cylinder stroke out-end check		S	S	S	S	S	S
Chuck cylinder check valve		S	S	S	S	S	S
Low hydraulic pressure detection switch		S	S	S	S	S	S
Over travel (soft limit)		S	S	S	S	S	S
Load monitoring function		O	O	O	O	O	O

*1 Standard on "M" models.

*2 GA-2000/300 model & GA-3000 series models only.

		GA-2000	GA-2600	GA-2800	GA-3000	GA-3300	GA-3600
OTHERS							
Electrical cabinet	Heat exchanger	S	S	S	S	S	S
	A/C cooling system	O	O	O	O	O	O
Complete hydraulic system		S	S	S	S	S	S
Hydraulic oil intercooler system		S	S	S	S	S	S
Advanced auto lubrication system		S	S	S	S	S	S
Foundation leveling & maintenance tool kit		S	S	S	S	S	S
Emergency maintenance electrical part package		S	S	S	S	S	S

		O _i -TF Plus	31i
FANUC CONTROL FUNCTIONS			
Display	10.4" color LCD	S	S
Graphic function	Standard	S	-
	Dynamic*1	O	S
Part program storage size	1M bytes	-	S
	2M bytes	S	O
O _i -TF Plus : each path	4M bytes	-	O
	8M bytes	-	O
Registerable programs	1,000	S	S
	4,000	-	O
31i : total	99	-	S
	128	S	-
Tool offset pairs	200	O	O
	400	-	O
O _i -TF Plus : each path	499	-	O
	999	-	O
31i : total	2000	-	O
	HRV 3	S	S
Servo HRV control		S	S
Automatic data backup		S	S
Synchronous / Composite control		O	O
Inch / metric conversion		S	S
Polar coordinate interpolation		S	S
Cylindrical interpolation		S	S
Multiple repetitive cycle		S	S
Rigid tapping		S	S
Unexpected disturbance torque detection function		S	S
Spindle orientation		S	S
Spindle speed fluctuation detection		S	S
Embedded macro		O	O
Spindle synchronous control		S	S
Run hour and parts count display		S	S
Tool radius / Tool nose radius compensation		S	S
Polygon turning		S	S
Helical interpolation		O	O
Direct drawing dimension programming		S	S
Thread cutting retract		S	S
Variable lead threading		S	S
Multiple repetitive cycle II		S	S
Canned cycles for drilling		S	S
Tool nose radius compensation		S	S
Chamfering / Corner R		S	S
AI contour control I		O	S
Multi part program editing		S	S
Manual handle retrace		O	O
Manual intervention and return		S	O
External data input		S	S
Addition of custom macro		S	S
Increment system C		S	S
Run hour & parts counter		S	S
Auto power-off function		S	S
RS-232 port		S	S
Memory card input / output (CF + USB)		S	S
Ethernet		S	S

*1 Dynamic graphic display conflict to MANUAL GUIDE *i*, only can choose one to have.

MANUAL GUIDE *i* is standard on 31i controller.

Specifications are subject to change without notice.

MACHINE SPECIFICATIONS

■ : Metric ■ : Inch

CAPACITY	GA-2000		GA-2600		GA-2800	
Max. swing diameter			Ø 580 mm 22.83"			
Swing over saddle			Ø 400 mm 15.75"			
Max. turning diameter			Ø 350 mm 13.78"			
Std. turning diameter			Ø 203 mm / Ø 254 mm 8" / 10"			
Max. turning length*1	309 / 624 / 1,204 mm 12" / 24.57" / 47.4"		291 / 606 / 1,186 mm 11.46" / 23.86" / 46.7"		260 / 575 / 1,155 mm 10.23" / 22.63" / 45.47"	
Max. work piece weight*2	170 kg 374 lb		230 kg 507 lb		250 kg 551 lb	
Chuck size	Ø 8"		Ø 10"		Ø 10"	
Bar capacity	Ø 51 mm 2"		Ø 65 mm 2.5"		Ø 75 mm 3"	
SPINDLE						
Hole through draw tube	Ø 52 mm 2"		Ø 65.5 mm 2.5"		Ø 76 mm 3"	
Hole through spindle	Ø 66 mm 2.6"		Ø 76 mm 3"		Ø 90 mm 3.5"	
Spindle bearing diameter	Ø 100 mm 4"		Ø 120 mm 4.72"		Ø 130 mm 5.12"	
Hydraulic cylinder	8"		10"		10"	
Spindle nose	A2-6		A2-8		A2-8	
Motor output (cont.)			11 kW 15 HP			
Motor output (30 min.)			15 kW 20 HP			
Motor full output speed			750 rpm			
Spindle drive system			Direct Belt Drive			
Spindle drive ratio	4 : 5		2 : 3		7 : 12	
Spindle speed range	48 ~ 4,800 rpm		40 ~ 4,000 rpm		35 ~ 3,500 rpm	
Spindle full output speed	600 rpm		500 rpm		440 rpm	
Spindle torque (30 min.)	238 Nm 175 lb-ft		286 Nm 210 lb-ft		325 Nm 239 lb-ft	
Spindle torque (peak)	175 Nm 129 lb-ft		211 Nm 155 lb-ft		240 Nm 177 lb-ft	
2-SPEED SPINDLE (OPTIONAL)						
Spindle speed ranges	L	20 ~ 1,200 rpm		20 ~ 1,000 rpm		20 ~ 875 rpm
	H	1,201 ~ 4,800 rpm		1,001 ~ 4,000 rpm		876 ~ 3,500 rpm
Spindle full output speed	L	400 rpm		333 rpm		291 rpm
	H	600 rpm		500 rpm		440 rpm
Spindle torque (15 min.)	L	360 Nm 265 lb-ft		430 Nm 317 lb-ft		497 Nm 366 lb-ft
Spindle torque (30 min.)	H	238 Nm 175 lb-ft		286 Nm 210 lb-ft		325 Nm 239 lb-ft
Cf-AXIS SPINDLE (OPTIONAL)						
Drive type			AC Servo Motor 0.7 kW 1 HP			
Torque output / Max. speed			240 Nm 177 lb-ft / 33 rpm			
X & Z AXES						
Max. X-axis travel*3			205 mm 8"			
Max. Z-axis travel*1			350 / 650 / 1,230 mm 13.78" / 25.6" / 48.43"			
X / Z axes rapids			20 / 24 m/min. 788 / 945 IPM			
Slide way type			Hardened & Ground Box Ways			
Feed rates			1 ~ 4,800 mm/min. 1 ~ 189 IPM			
X-axis servo motor			AC 2.7 kW 3.6 HP			
Z-axis servo motor			AC 2.7 kW 3.6 HP			
X-axis ball screw Ø / pitch			Ø 32 mm / 8 mm 1.25" / 0.31"			
Z-axis ball screw Ø / pitch			Ø 36 mm / 8 mm 1.42" / 0.31"			
X / Z axes thrust (cont.)			962 kg 2,121 lb			

*1 GA-2000/300 / GA-2000 / GA-2000L

*3 Individual models may vary, please see interference drawings.

*2 Work-piece supported by chuck & tailstock.

CAPACITY		GA-3000	GA-3300	GA-3600
Max. swing diameter			Ø 600 mm 23.62"	
Swing over saddle			Ø 500 mm 19.69"	
Max. turning diameter			Ø 500 mm 19.69"	
Std. turning diameter			Ø 225 mm 8.85"	
Max. turning length*4		629 / 929 / 1,229 mm 24.76" / 36.57" / 48.39"	624 / 924 / 1,224 mm 24.57" / 36.38" / 48.19"	596 / 896 / 1,196 mm 23.46" / 35.27" / 47.09"
Max. work piece weight*2		340 kg 750 lb	340 kg 750 lb	340 kg 750 lb
Chuck size		Ø 10" (12")	Ø 12" (15")	Ø 15"
Bar capacity		Ø 75 mm 3"	Ø 90 mm 3.5"	Ø 105 mm 4"
SPINDLE				
Hole through draw tube		Ø 75.5 mm 3"	Ø 90.5 mm 3.5"	Ø 105.5 mm 4"
Hole through spindle		Ø 90 mm 3.5"	Ø 101 mm 4"	Ø 121 mm 4.7"
Spindle bearing diameter		Ø 130 mm 5.11"	Ø 140 mm 5.51"	Ø 160 mm 6.3"
Hydraulic cylinder		10"	12"	15"
Spindle nose		A2-8	A2-8	A2-11
Motor output (cont.)			18.5 kW 25 HP	
Motor output (30 min.)			22 kW 30 HP	
Motor full output speed			400 / 575 rpm	
Spindle drive system			Direct Belt Drive	
Spindle drive ratio		7 : 10	7 : 10	35 : 54
Spindle speed range		30 ~ 3,000 rpm	30 ~ 3,000 rpm	25 ~ 2,500 rpm
Spindle full output speed		403 rpm	403 rpm	373 rpm
Spindle torque (30 min.)		522 Nm 385 lb-ft	522 Nm 385 lb-ft	563 Nm 415 lb-ft
Spindle torque (peak)		439 Nm 323 lb-ft	439 Nm 323 lb-ft	473 Nm 348.8 lb-ft
GEAR BOX SPINDLE (OPTIONAL)				
Spindle speed ranges	L	30 ~ 1,050 rpm	30 ~ 1,050 rpm	30 ~ 1,000 rpm
	H	1,050 ~ 3,000 rpm	1,050 ~ 3,000 rpm	1,000 ~ 2,500 rpm
Spindle full output speed	L	263 rpm	263 rpm	239 rpm
	H	1,050 rpm	1,050 rpm	955 rpm
Spindle torque (15 min.)	L	946 Nm 697 lb-ft	946 Nm 697 lb-ft	1,040 Nm 767 lb-ft
Spindle torque (30 min.)	H	237 Nm 174 lb-ft	237 Nm 174 lb-ft	260 Nm 191 lb-ft
Cf-AXIS SPINDLE (OPTIONAL)				
Drive type		AC Servo Motor 1.0 kW 1.3 HP		
Torque output / Max. speed		480 Nm 354 lb-ft / 33 rpm		
X & Z AXES				
Max. X-axis travel*3		260 mm 10.24"		
Max. Z-axis travel*4		630 / 930 / 1,230 mm 24.8" / 36.61" / 48.43"		
X / Z axes rapids		20 / 24 m/min. 788 / 945 IPM		
Slide way type		Hardened & Ground Box Ways		
Feed rates		1 ~ 4,800 mm/min. 1 ~ 189 IPM		
X-axis servo motor		AC 2.7 kW 3.6 HP		
Z-axis servo motor		AC 4.5 kW 6 HP		
X-axis ball screw Ø / pitch		Ø 36 mm / 8 mm 1.42" / 0.31"		
Z-axis ball screw Ø / pitch		Ø 45 mm / 10 mm 1.77" / 0.39"		
X / Z axes thrust (cont.)		962 kg / 1,411 kg 2,121 lb / 3,111 lb		

*4 GA-3000 / GA-3000/900 / GA-3000L

Specifications are subject to change without notice.

MACHINE SPECIFICATIONS

■ : Metric ■ : Inch

TURRET	GA-2000	GA-2600	GA-2800
Stations	12 Std. / 10 Opt.		
Indexing drive	AC Servo motor		
Indexing speed	0.2 sec. Adjacent / 0.5 sec. 180 degrees (Single step)		
Accuracy	Positioning: ± 0.00069°, Repeatability: ± 0.00027°		
O.D. tool shank size	□ 25 mm 1"		
I.D. tool shank size	∅ 40 mm 1-1/2"		
LIVE TOOLING TURRET (OPTIONAL)			
Stations	12		
Live tooling stations	12		
Live tooling drive type	4.5 kW 6 HP , 22 Nm 16.2 lb-ft (Intermittent) AC Servo motor		
Indexing drive type	AC Servo motor		
Index speed	0.2 sec. Adjacent / 0.5 sec. 180 degrees (Single step)		
O.D. tool shank size	□ 25 mm 1"		
I.D. tool shank size	∅ 40 mm 1-1/2"		
Live tooling shank size	ER 32		
Live tooling RPM range	40 ~ 4,000 rpm		
TAILSTOCK			
Quill center taper	MT#4 (Live Center)		
Quill diameter / travel	∅ 70 mm / 150 mm 2.75" / 5.9"		
Tailstock base travel*1	Fixed / 550 mm / 1,140 mm 21.65" / 44.88"		
Programmable quill / base	Yes / Yes (Not available on GA-2000/300 series)		
Programmable base type	Positioned by Z-axis carriage		
PARTS CATCHER (OPTIONAL)			
Max. part diameter	∅ 77 mm 3"		
Max. part length	150 mm 5.9"		
GENERAL			
Positioning accuracy	0.01 mm 0.00039"		
Repeatability	± 0.003 mm ± 0.00012"		
Standard CNC control	FANUC Oi-TF Plus		
Voltage / Power requirement	AC 200 / 220 +10% to -15% 3 phase / 26 kVA		
Hydraulic tank capacity	30 / 40 / 40 L 7.9 / 10.5 / 10.5 gal		
Coolant tank capacity	145 L (GA-2000/300 : 100 L) 38.3 gal (26.4 gal)		
Coolant pump	3 bar rated at 42.6 PSI		
Machine weight*1	3,500 / 4,000 / 4,600 kg 7,717 / 8,820 / 10,143 lb		
Dimensions L × W × H*2	2,014 x 1,630 x 1,725 mm 79" x 64" x 68"	2,445 x 1,630 x 1,890 mm 96" x 64" x 74"	3,345 x 1,630 x 1,845 mm 132" x 64" x 73"
Dimensions L × W × H*2 (machine w/chip conveyor)	2,014 x 2,360 x 1,725 mm 79" x 93" x 68"	3,429 x 1,630 x 1,890 mm 135" x 64" x 74"	4,112 x 1,630 x 1,845 mm 161" x 64" x 73"

Specifications are subject to change without notice.

*1 GA-2000/300 / GA-2000 / GA-2000L

TURRET	GA-3000	GA-3300	GA-3600
Stations	12 Std. / 10 Opt.		
Indexing drive	AC Servo motor		
Indexing speed	0.3 sec. Adjacent / 0.5 sec. 180 degrees (Single step)		
Accuracy	Positioning: ± 0.00069°, Repeatability: ± 0.00027°		
O.D. tool shank size	□ 25 mm 1"		
I.D. tool shank size	∅ 40 mm (∅ 50 mm Opt.) 1-1/2" (2")		
LIVE TOOLING TURRET (OPTIONAL)			
Stations	12		
Live tooling stations	12		
Live tooling drive type	4.5 kW 6 HP , 22 Nm 16.2 lb-ft (Intermittent) AC Servo motor		
Indexing drive type	AC Servo motor		
Index speed	0.2 sec. Adjacent / 0.5 sec. 180 degrees (Single step)		
O.D. tool shank size	□ 25 mm 1"		
I.D. tool shank size	∅ 40 mm (∅ 50 mm Opt.) 1-1/2" (2")		
Live tooling shank size	ER 32		
Live tooling RPM range	40 ~ 4,000 rpm		
TAILSTOCK			
Quill center taper	MT#5 (Live center) [MT#4 (Dead center) Opt.]		
Quill diameter / travel	∅ 110 mm / 150 mm 4.3" / 5.9"		
Tailstock base travel*2	450 mm / 750 mm / 1,050 mm 17.7" / 29.5" / 41.3"		
Programmable quill / base	Yes / Yes		
Programmable base type	Positioned by Z-axis carriage		
PARTS CATCHER (OPTIONAL)			
Max. part diameter	∅ 105 mm 4.13"		
Max. part length	180 mm 7"		
GENERAL			
Positioning accuracy	0.01 mm 0.00039"		
Repeatability	± 0.003 mm ± 0.00012"		
CNC controller	FANUC Oi-TF Plus		
Voltage / Power requirement	AC 200 / 220 +10% to -15% 3 phase / 38 kVA		
Hydraulic tank capacity	40 L 10.5 gal		
Coolant tank capacity	145 L 38.3 gal		
Coolant pump	3 bar rated at 42.6 PSI		
Machine weight*2	5,800 / 6,500 / 7,000 kg 12,789 / 14,332 / 15,435 lb		
Dimensions L × W × H*2	2,845 x 1,965 x 1,910 mm 112" x 77" x 75"	3,165 x 1,980 x 1,910 mm 125" x 78" x 75"	3,642 x 1,965 x 1,910 mm 143" x 77" x 75"
Dimensions L × W × H*2 (machine w/chip conveyor)	3,840 x 1,965 x 1,910 mm 152" x 77" x 75"	4,160 x 1,980 x 1,910 mm 165" x 78" x 75"	4,637 x 1,965 x 1,910 mm 183" x 77" x 75"

Specifications are subject to change without notice.

*2 GA-3000 / GA-3000/900 / GA-3000L



GOODWAYCNC.com

GOODWAY MACHINE CORP.

HEADQUARTERS

No.13, 5th Road,
Taichung Industrial Park,
Taichung City, 407, Taiwan
E-mail : goodway@goodwaycnc.com

CENTRAL TAIWAN SCIENCE PARK BRANCH

No. 38, Keyuan Road,
Central Taiwan Science Park.Taichung,
Taichung City, 407, Taiwan
TEL : + 886-4-2463-6000
FAX : + 886-4-2463-9600

GOODWAY MACHINE (WUJIANG) CO.,LTD

No. 4888, East Lake Taihu Avenue, Wujiang
Economic and Technological Development Zone,
Jiangsu, China
Sales Hotline : + 86-512-8286-8068
Service Hotline : + 86-512-8286-8066
FAX : + 86-512-8286-8620
E-mail : goodway@goodwaycnc.cn