

GTW-1500 SERIES

TURRET / GANG TOOLING
MULTI-AXIS CNC TURNING CENTER



THE ULTIMATE MACHINING POWER
WOODWAY®

TURRET / GANG TOOLING MULTI-AXIS TURNING CENTER

With the latest technology and high quality components of the industry, GOODWAY GTW series multi-axis turning centers combined with multi-axis, high efficiency and high performance especially developed for medical & automobile industry. It can easily complete the complex front and rear side machining of work-piece with high efficiency and high precision machining performance. It's perfectly once again annotating a new standard of multi-axis turning center.

- Combined with live tooling turret and gang tooling systems is more convenient for programming, and makes series high efficiency and economic.
- Brand new design of X-axis on sub-spindle provides extra working space. The gang tooling can continue working after catch the work-piece from sub-spindle, which increases the efficiency of machining.
- Standard twin Y-axis function with live tooling turret, gang tooling system and C-axis can improve the ability for complex machining and accuracy.
- With separated coolant tank and rear discharge of chips conveyor design, it is easy to maintain and provide high efficiency for cooling.



■ Gang tooling system

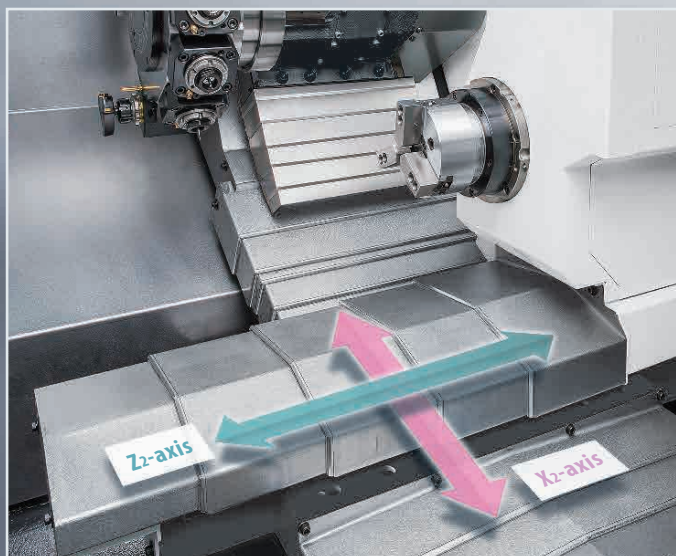

■ Sub-spindle X₂ & Z₂ axes



Maximum Performance Online



(GTW-1500 series with optional accessories.)

SUPER RIGID STRUCTURE

- By using Finite Element Analysis (FEA), the optimal reinforced ribs are directly cast into the integrated base. Mechanical rigidity has been increased sharply compared to conventional design. The GTW series is capable of performing super-duty turning and maintain long-term super high-precision accuracy.
- The heavily ribbed, thermally balanced, super rigidity of "Meehanite" grade casting is capable of with standing much greater stress without deforming and provides maximum vibration dampening, which result in a machine that will outlast and outperform the competition.
- Contract surfaces of all slides, spindles, turrets and ball screw bearing housings and base are precisely hand scrapped to provide maximum assembly precision, structural rigidity, and load distribution.
- X, Y and Z axes uses high speed, high accuracy linear guide ways design and stretch to reach maximum intensity and accuracy, which can ensure the structural rigidity and reach the rapid feed rate.
- X, Y and Z axes are driven by high class FANUC absolute AC servo motors, and provide tremendous thrust output with faster acceleration / deceleration.

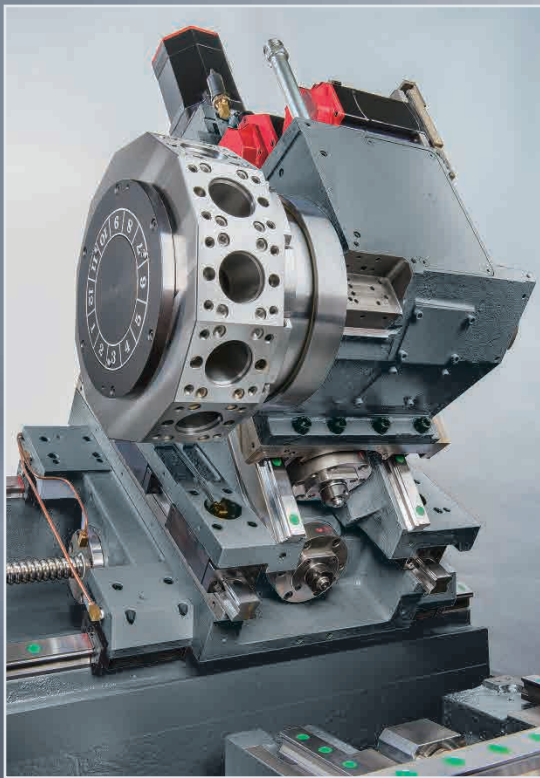

- 30° slant bed design provides extremely stable base and saddle.



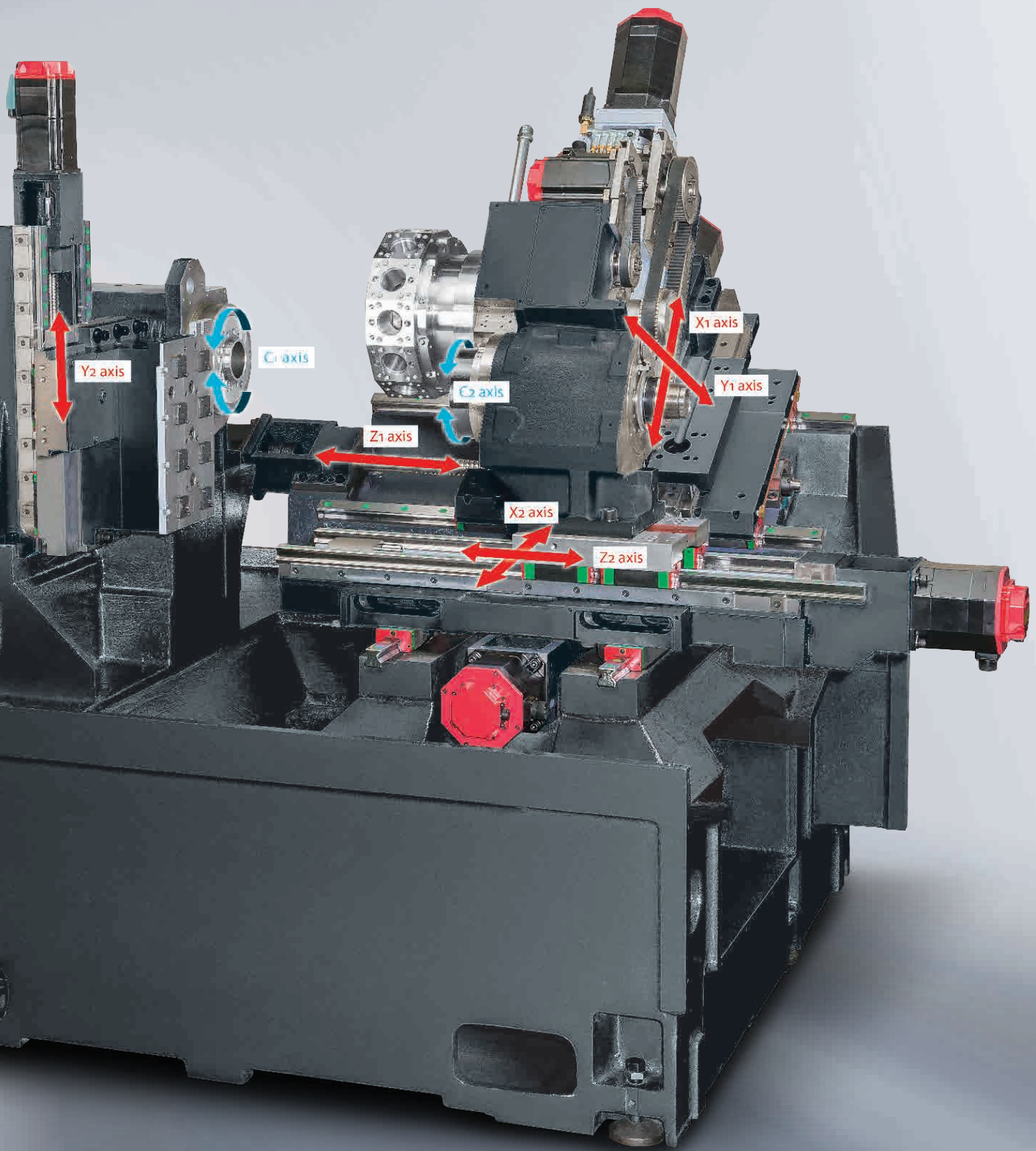

(Main construction of GTW-1500 series.)

FLEXIBLE MACHINING MODE

The turret can support main and sub-spindle while machining. Gang tooling system is specially for rear side of machining on sub-spindle. The specialized tooling system features with loading and unloading system, which provides flexible and high efficiency mode. From bar feeding, processing and discharging can all be completed at once in one machine.

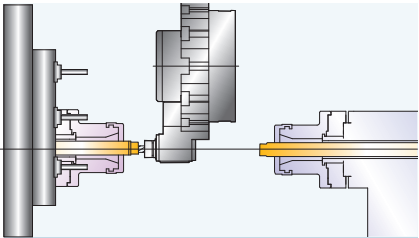
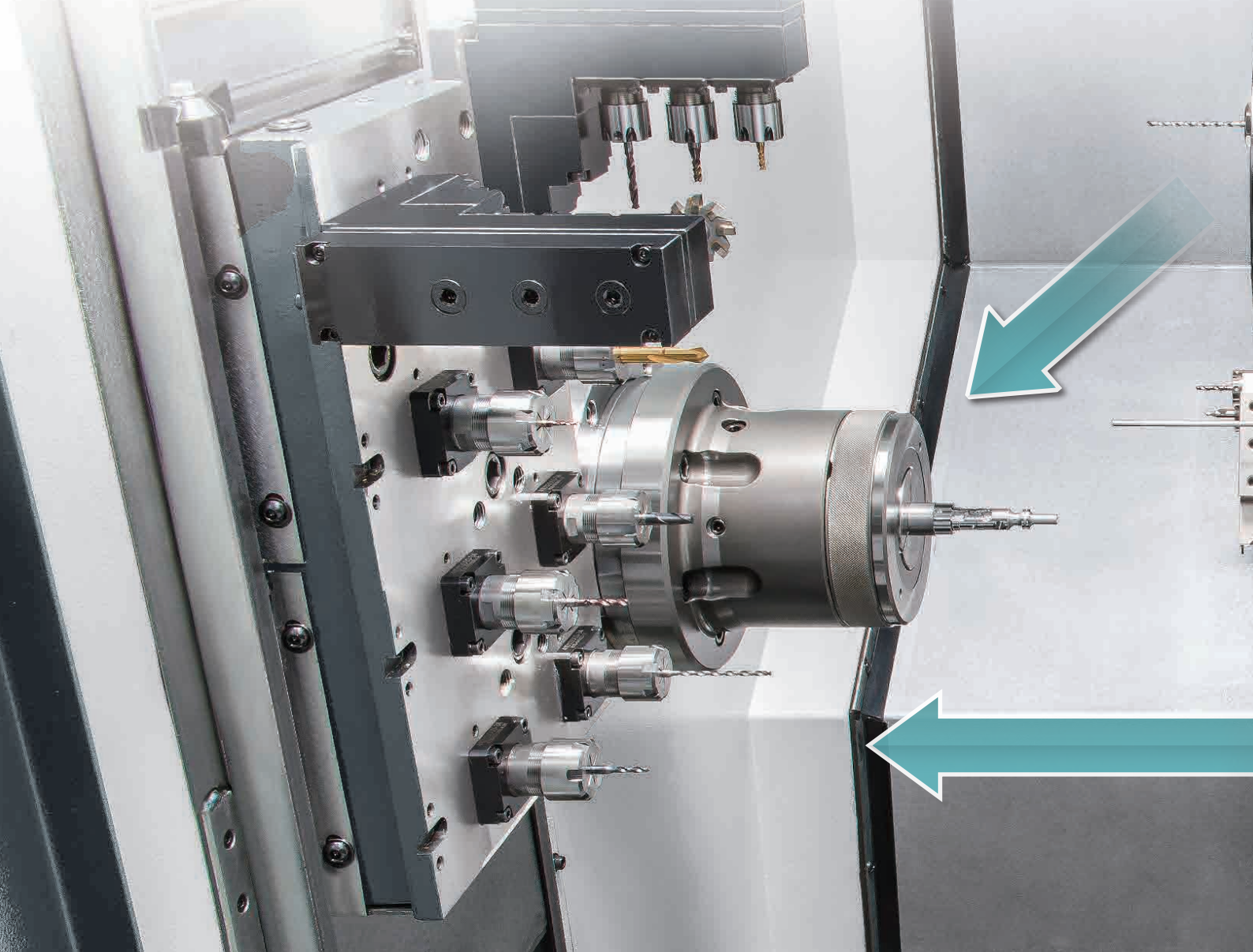

A1 Front side machining

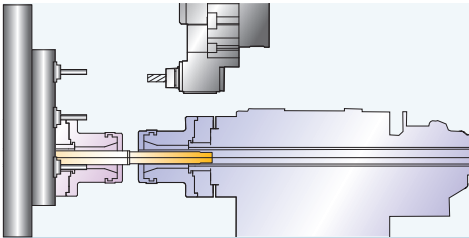

A2 Sub-spindle clamps the work-piece

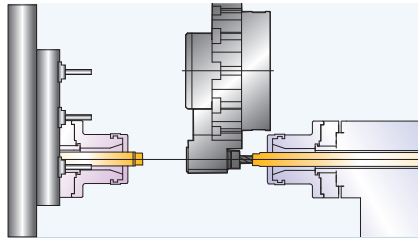

A3 Rear side machining

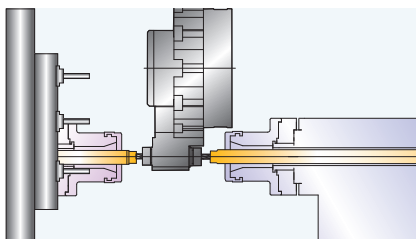
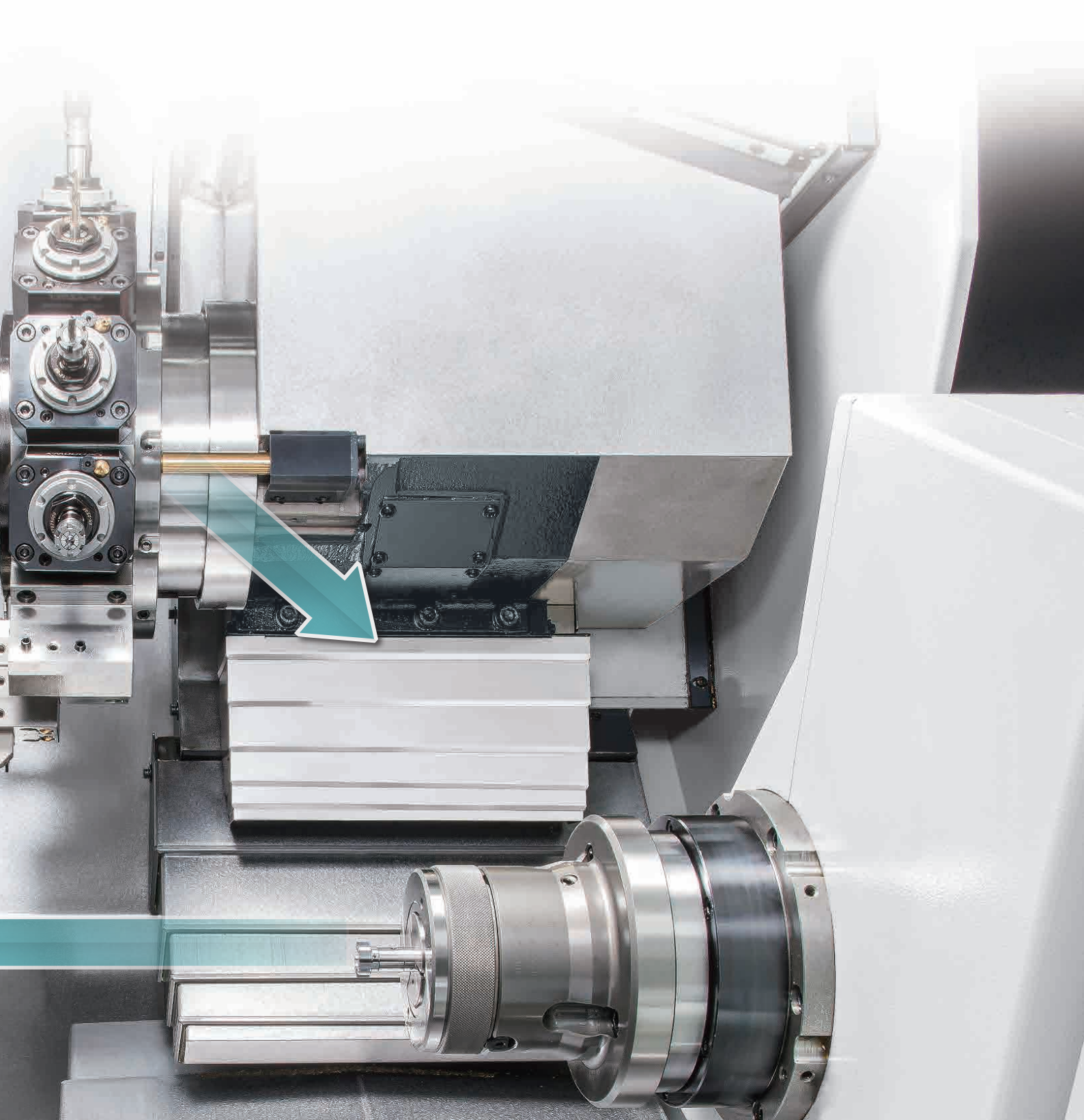

B Front / rear sides machining in the same time

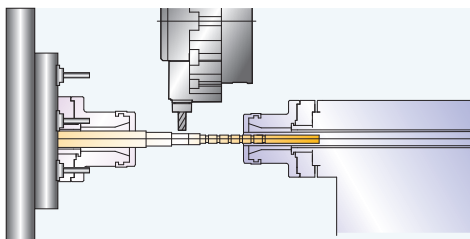

C Corresponding machining on both main and sub-spindle

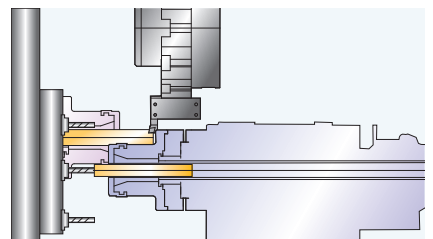

D Gang tooling machining on rear side of work-piece

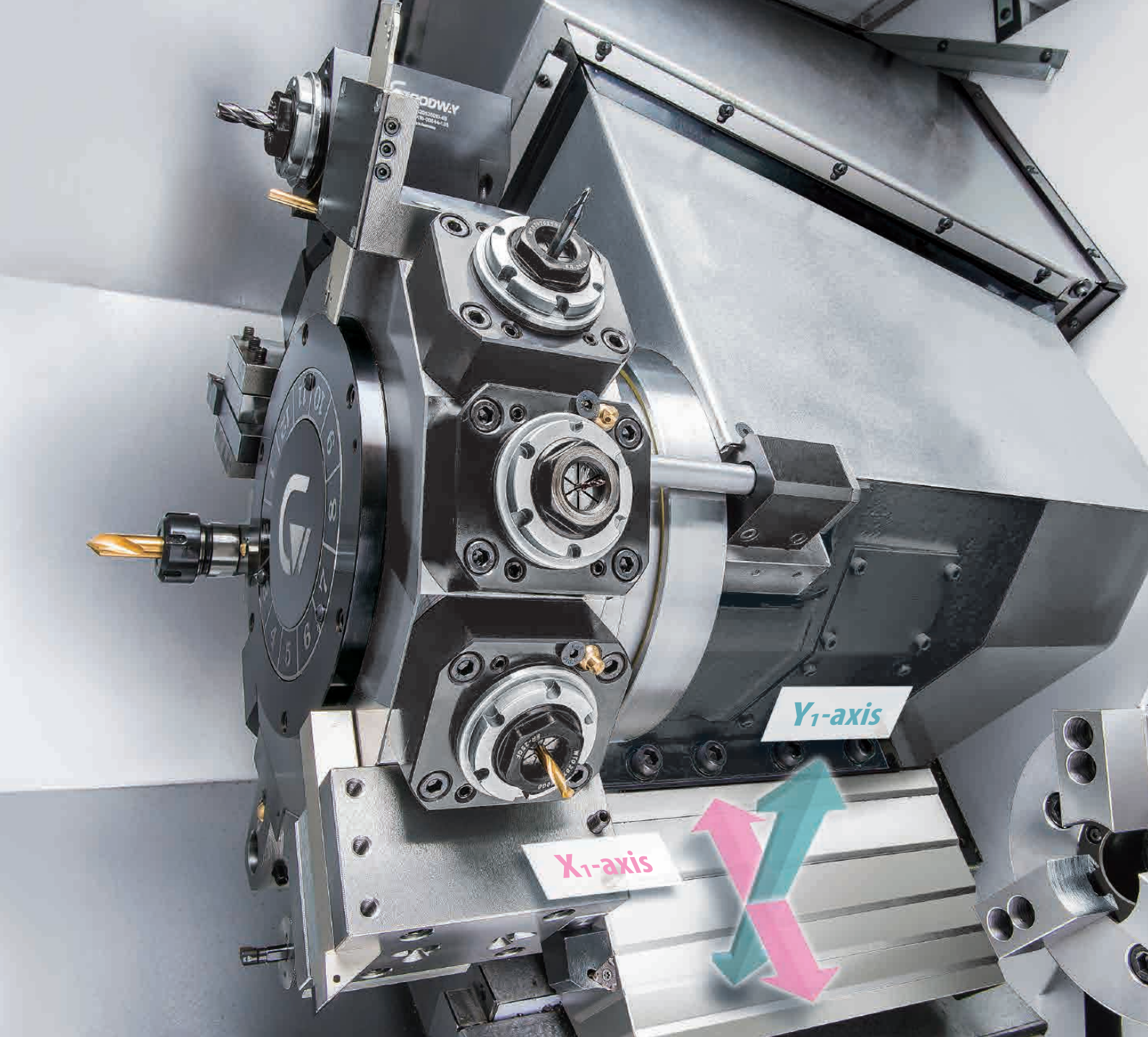

LIVE TOOLING TURRET & Y-AXIS

- Adopt super high precision curvic couplings accurately positioning turret disk ensures the rigidity of turret in any cutting conditions.
- Heavy load servo indexing turret features the latest turret disk technology, achieving 0.2 second indexing for adjacent stations and 0.5 second for stations at the opposite end of the disk.
- 12-station live tooling turret is available for option, and only the working tools are spinning with the rest tools are not, which can save the wear of the tool.
- Y_1 -axis travel : 70 mm = ± 35 mm, Y_1 -axis and X_1 -axis direction included angle 30°, the gravity of turret is always located on the range of the saddle to ensure the rigidity of full travel.

Torque Output of Live Tools

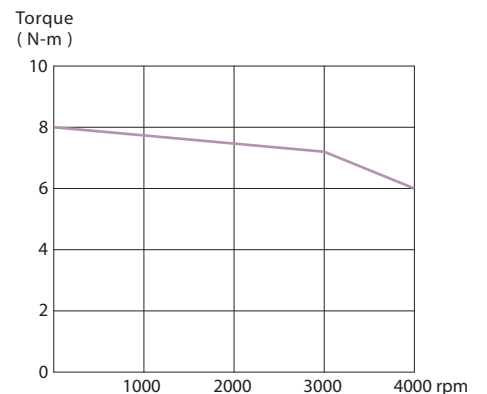

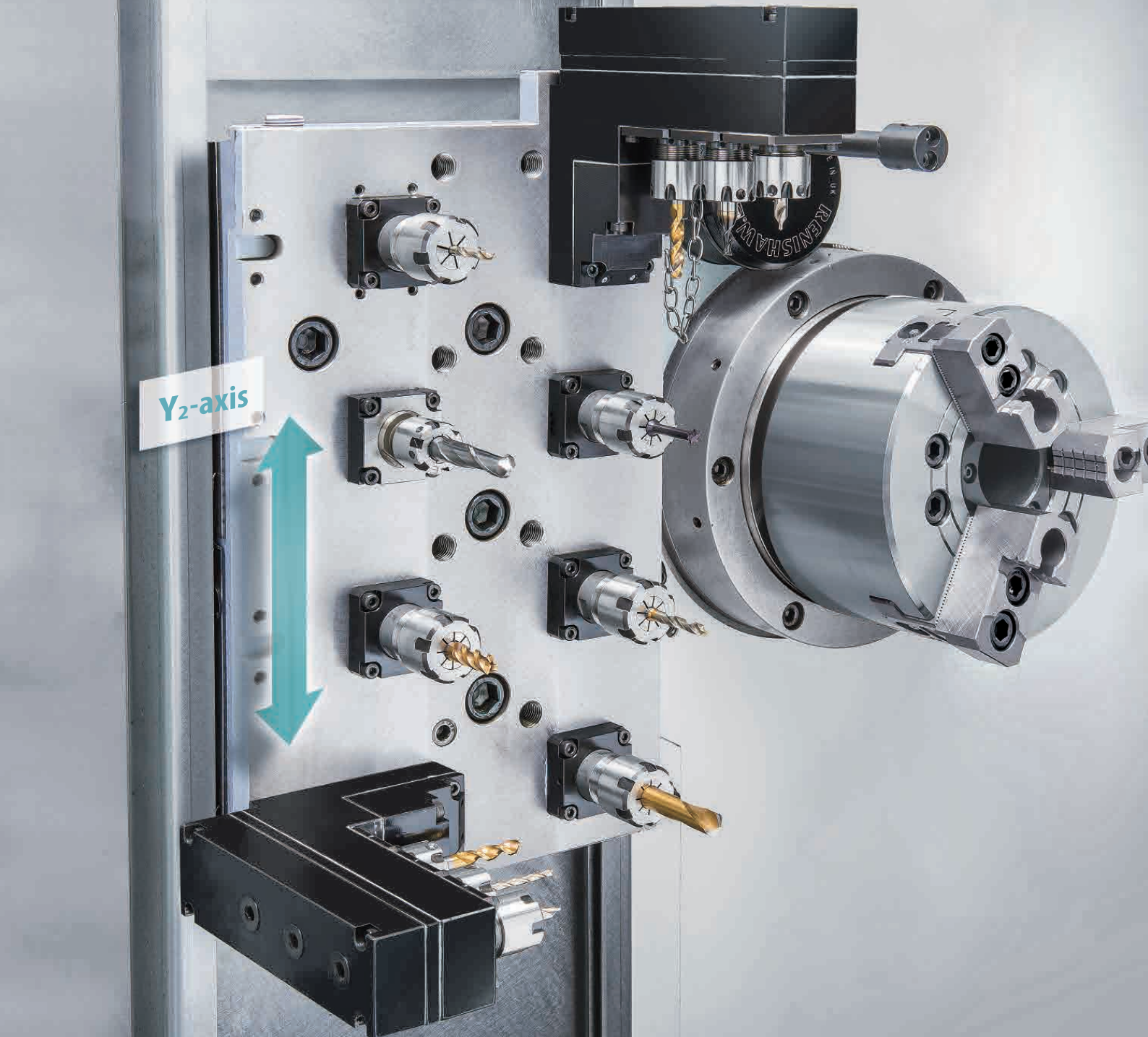

GANG TOOLING SYSTEM & Y-AXIS

- Gang tooling system provides 8-station live tooling and driven by AC servo motor with high torque, which can accomplish the hardest machining easily.
- Easy dismount design on gang tooling system is especially designed for sub-spindle. Rapid tool change, and no need to recede tools, which greatly improves the machining efficiency on rear side machining.
- Y₂-axis travel : 250 mm, rapid feed rate : 24 m/min. with rapid tool change and enable to perform multi-tasking for precise machining.

Torque Output of Live Tools

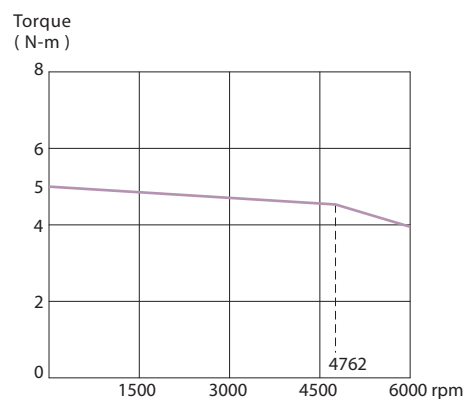

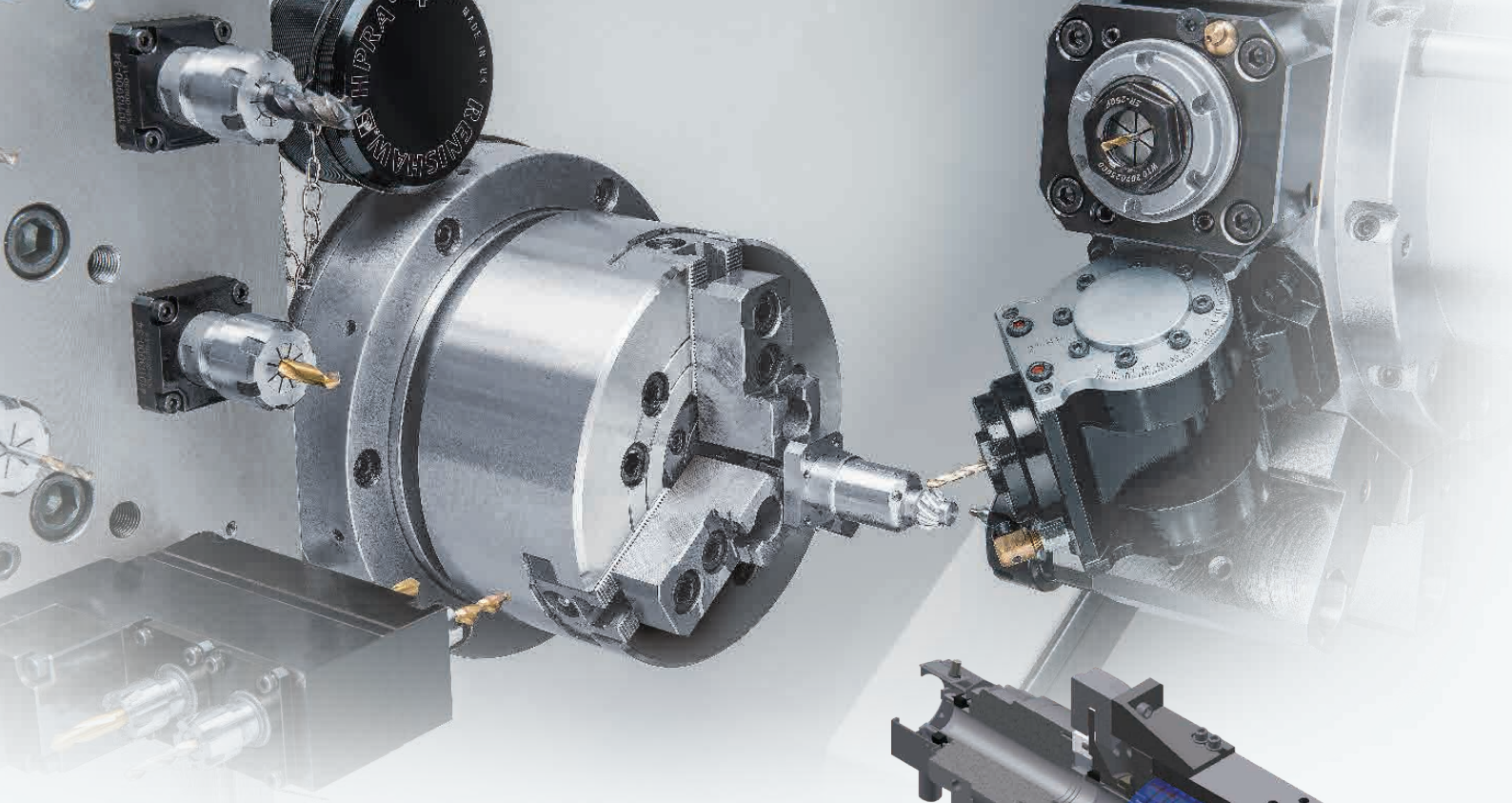

THE ULTIMATE MACHINING POWER

GANG TOOLING SYSTEM CAPABILITY	
Tapping (Dead)	10 mm
Tapping (Live)	8 mm
Drilling (Dead)	M8 x P1.25
Drilling (Live)	M6 x P1.0
Milling (Live)	10 mm

LIVE TOOLING TURRET MACHINING CAPABILITY					
	Tool Size	Spindle Speed (rpm)	Feedrate (mm/min.)	Cutting Speed (m/min.)	Cutting Depth (mm)
Drilling	Ø 16 mm HSS	500	—	25	—
End Mill	Ø 16 mm HSS	600	190	30	4
Tapping	M12 x P1.75	400	—	15	—

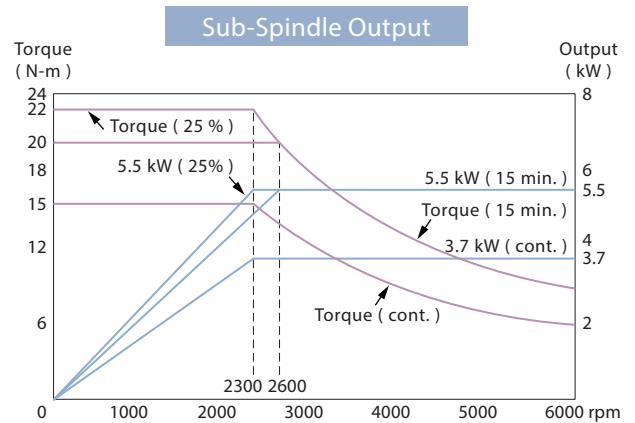
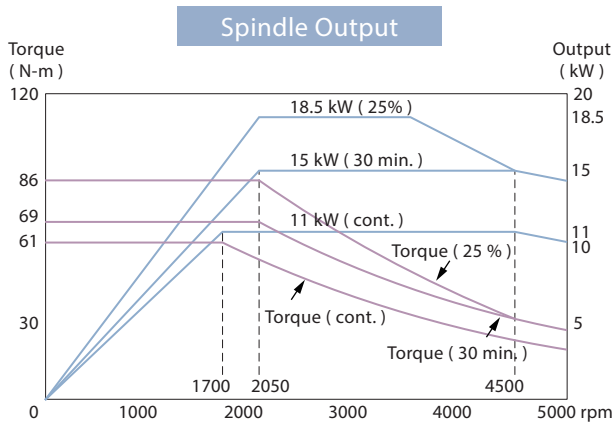

G.LINC 350 Option



Makes Your Machine Smarter

- ▶ Advanced Hardware
- ▶ Outstanding Operability
- ▶ Streamlined Programming
- ▶ High Security and Shortened Machining Setting
- ▶ Reliable Continuous Operation
- ▶ Shortened Troubleshooting Time
- ▶ Improved Utilization Rate
- ▶ 3D cutting simulation preview

Significant Production Efficiency

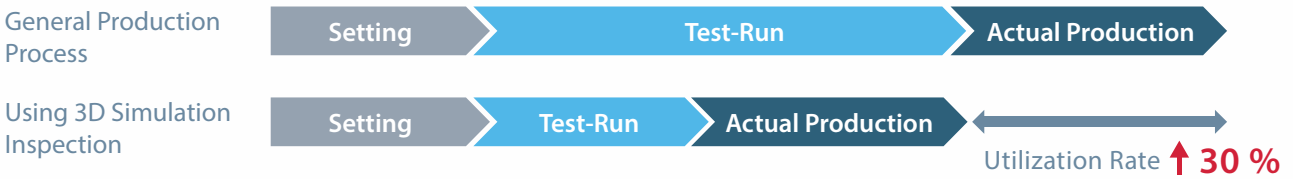

Comprehensive Functions

Programming	Setting	Test-Run	Actual Production	Daily Used
Dynamic graphic display Program management Friendly programming environment Programming auxiliary Manual Guide <i>i</i> Embedded E-manual	3D advance tool path and cutting simulation	Tool load monitor Program check Smart balance detection 3D Real-time cutting simulation Interference check (31 <i>i</i> option needed)	Tool load monitor 3D Real-time cutting simulation Interference check (31 <i>i</i> option needed) Load monitoring	Safety signal viewer Fast alarm check productivity Productivity management Twin operation system switch Maintenance management NFC apply authority management and record

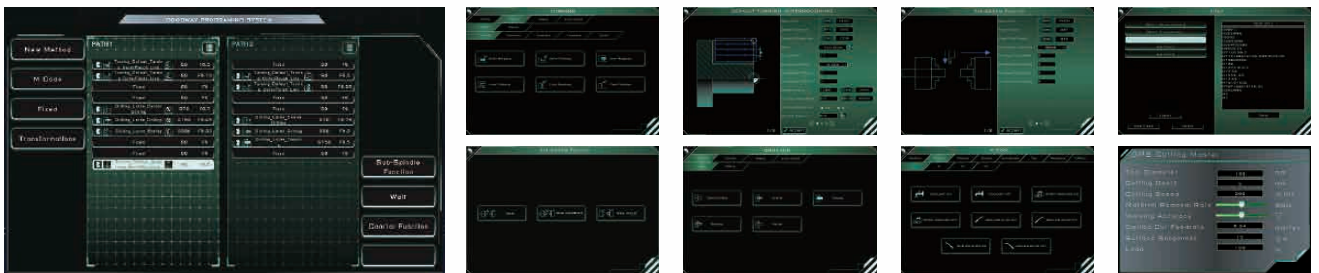

GENERAL DIMENSION

Work Range

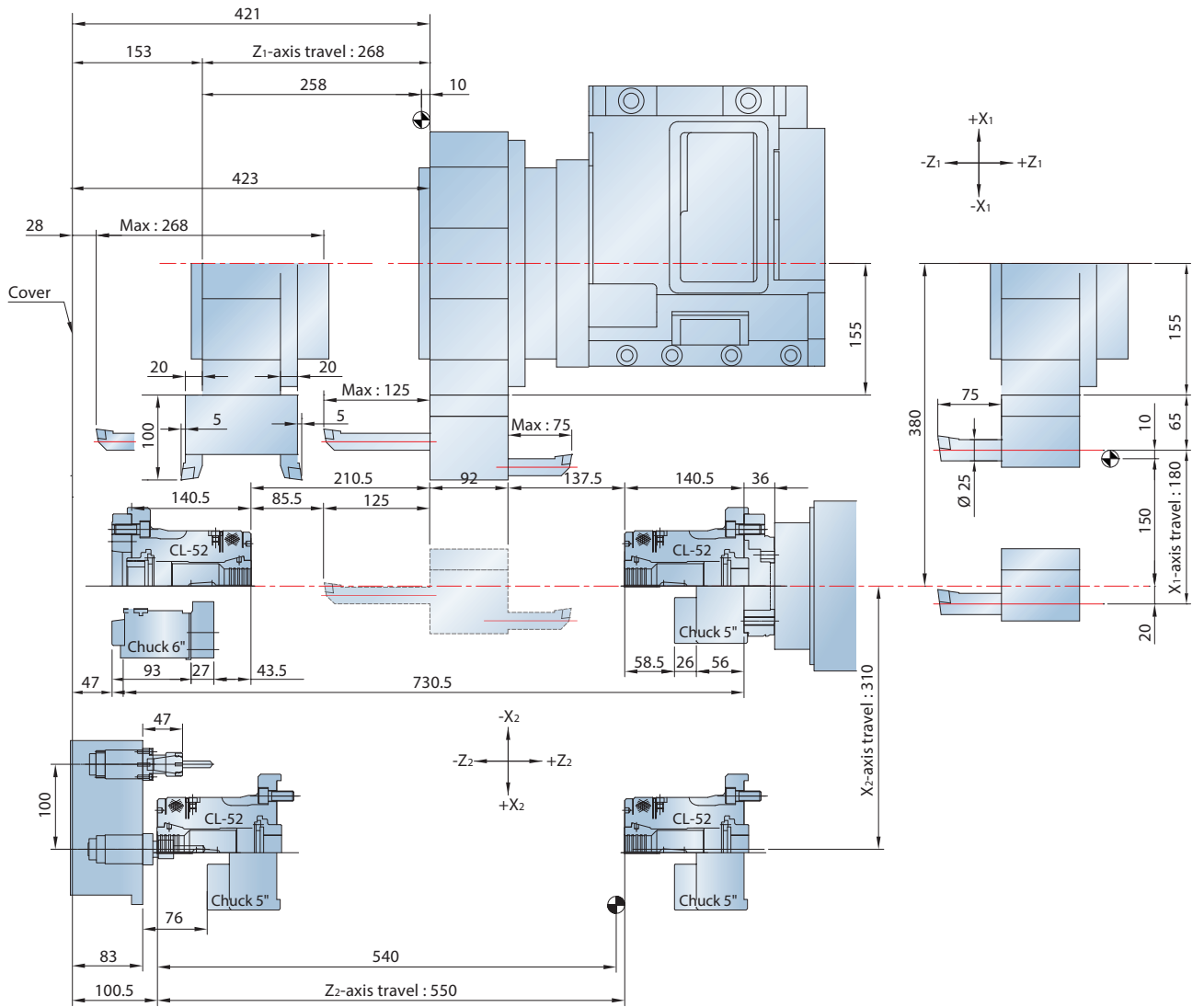

Unit : mm

Interference Diagram

[12-Station Live Tooling Turret]

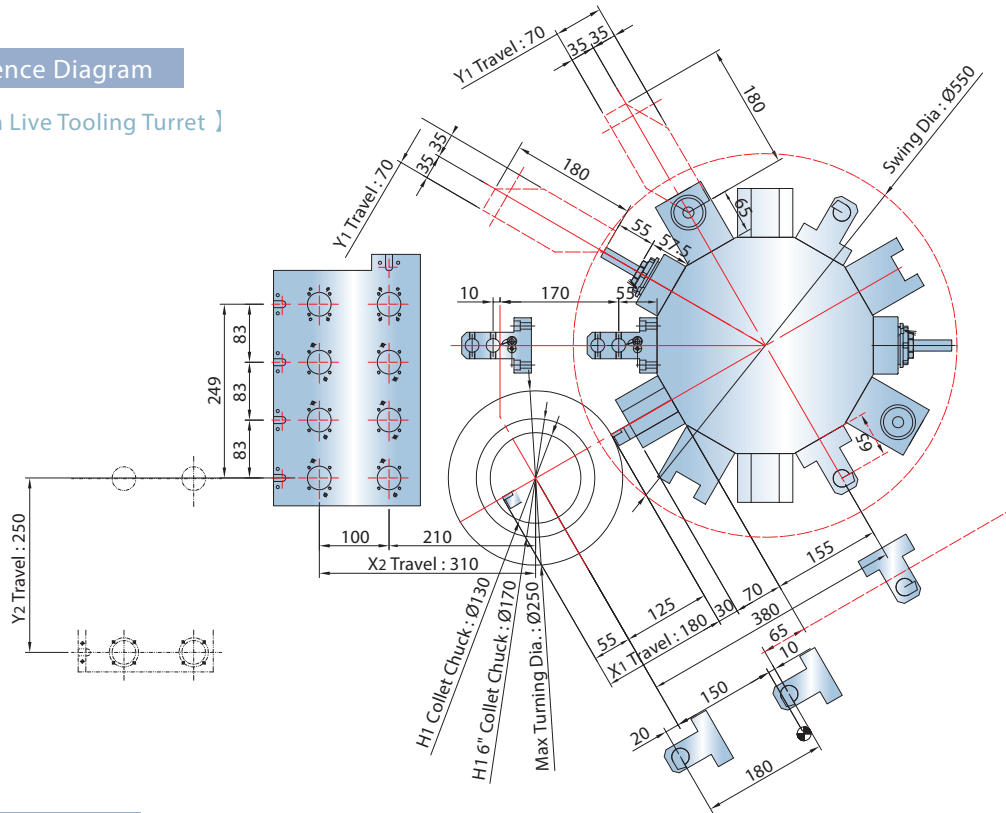

Tooling System

[12-Station Live Tooling Turret]

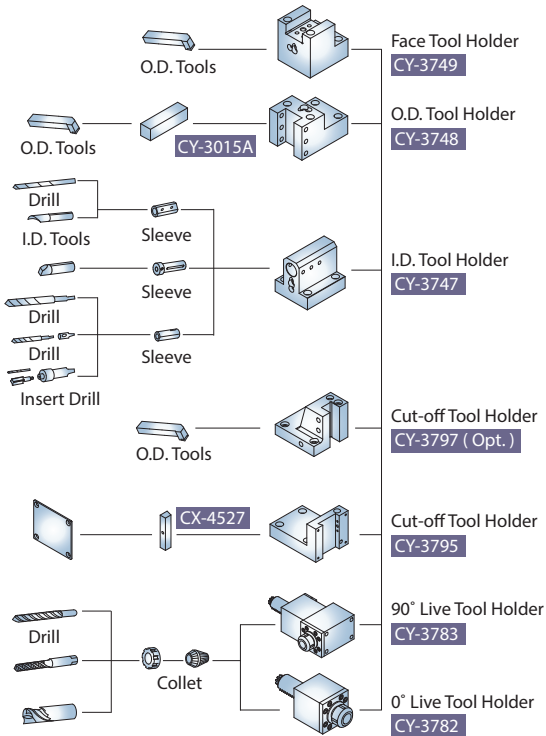

[Tooling System]

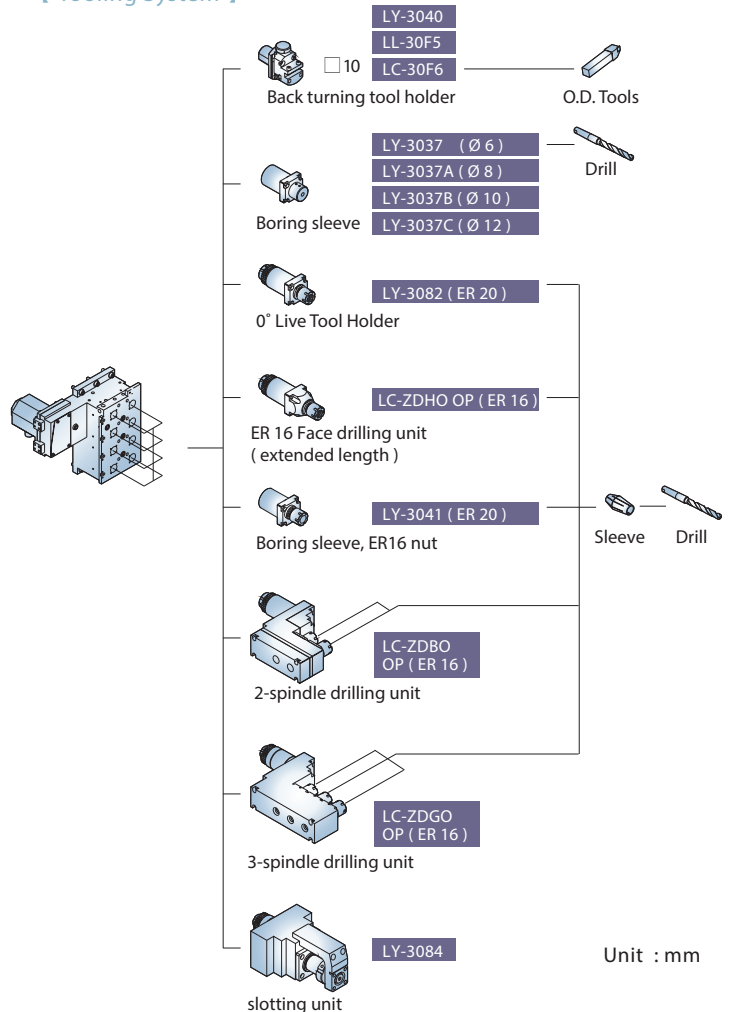

Unit : mm

MACHINE SPECIFICATIONS

■ : Metric ■ : Inch

SPECIFICATIONS		GTW-1500Y		
Max. turning diameter		Ø 250 mm 9.84"		
Max. swing diameter		Ø 400 mm 15.74"		
Max. turning length		210 mm 8.26"		
Chuck size	CL42	CL52	6"	
Bar capacity		Ø 51 mm 2"		
SPINDLE				
Hole through spindle		Ø 61 mm 2.4"		
Hole through draw tube		Ø 52 mm 2.04"		
Spindle nose		A2-5		
Spindle bearing diameter (front)		Ø 120 mm 4.72"		
Max. spindle speed		5,000 rpm		
Spindle torque (cont. / 30 min. / 25%)		61 / 69 / 86 N-m 45 / 50.8 / 63.4 lb-ft		
Spindle motor (cont. / 30 min. / 25%)		11 / 15 / 18.5 kW 15 / 20 / 25 HP		
SUB-SPINDLE				
Chuck size	CL42	CL52	5"	
Hole through spindle		Ø 43 mm 1.69"		
Spindle nose	Ø 140 mm 5.5"	Ø 170 mm 6.69"	Ø 110 mm 4.33"	
Spindle bearing diameter		Ø 90 mm 3.54"		
Max. spindle speed		6,000 rpm		
Spindle torque (cont. / 15 min. / 25%)		15 / 20 / 22 N-m 11 / 14.7 / 16.2 lb-ft		
Spindle motor (cont. / 30 min. / 25%)		3.7 / 5.5 / 5.5 kW 5 / 7.3 / 7.3 HP		
X / Z AXES				
X1 / X2 axes travel		180 / 310 mm 7.08" / 12.2"		
Z1 / Z2 axes travel		268 / 550 mm 10.55" / 21.6"		
X1 / X2 axes servo motor (cont.)		1.2 kW 1.6 HP		
Z1 / Z2 axes servo motor (cont.)		1.2 kW 1.6 HP		
X1 / X2 axes rapids		18 / 24 m/min. 708 / 945 IPM		
Z1 / Z2 axes rapids		30 m/min. 1,181 IPM		
X1 / X2 axes ball screw Ø x Pitch		Ø 32 mm 1.25" x Pitch 10 / Ø 36 mm 1.41" x Pitch 8		
Z1 / Z2 axes ball screw Ø x Pitch		Ø 32 mm 1.25" x Pitch10		
LIVE TOOLING TURRET				
Stations		12		
Turret disk diameter		Ø 310 mm 12.2"		
Live tooling drive motor		2.5 kW 3.3 HP		
Indexing drive motor		FANUC α 8 / 4000is		
O.D. tool shank size		□ 20 mm 3/4"		
I.D. tool shank size		Ø 25 mm 1"		
Live tooling shank size		ER 25 (Ø 16 mm) 0.62"		
Max. live tooling RPM		4,000 rpm		

■ : Metric ■ : Inch

Y-AXIS		GTW-1500Y		
Y1 / Y2 axes travel		± 35 / 250 mm	±1.37" / 9.84"	
Y1 / Y2 axes servo motor (cont.)		1.4 / 0.75 kW	1.8 / 1 HP	
Y1 / Y2 axes rapids		20 / 24 m/min.	788 / 945 IPM	
Y1 / Y2 axes ball screw Ø x Pitch		Ø 32 mm	1.25" x Pitch 6 / Ø 28 mm	1.1" x Pitch 6
GANG TOOLING SYSTEM				
Stations		8		
Live tools		ER20		
Max. live tooling RPM		6,000 rpm		
GENERAL				
Positioning accuracy (X / Y / Z)		± 0.005 mm	±0.00019"	
Repeatability (X / Y / Z)		± 0.003 mm	±0.00011"	
NC controller		G.LINC 350 (FANUC 32i)		
Coolant tank capacity		240 L	63 gal	
Machine weight		4,000 Kg	8,800 lb	
Dimensions (L × W × H)		2,545 x 2,065 x 2,015 mm	101" x 82" x 80"	

Specifications are subject to change without notice.

Machine Layout

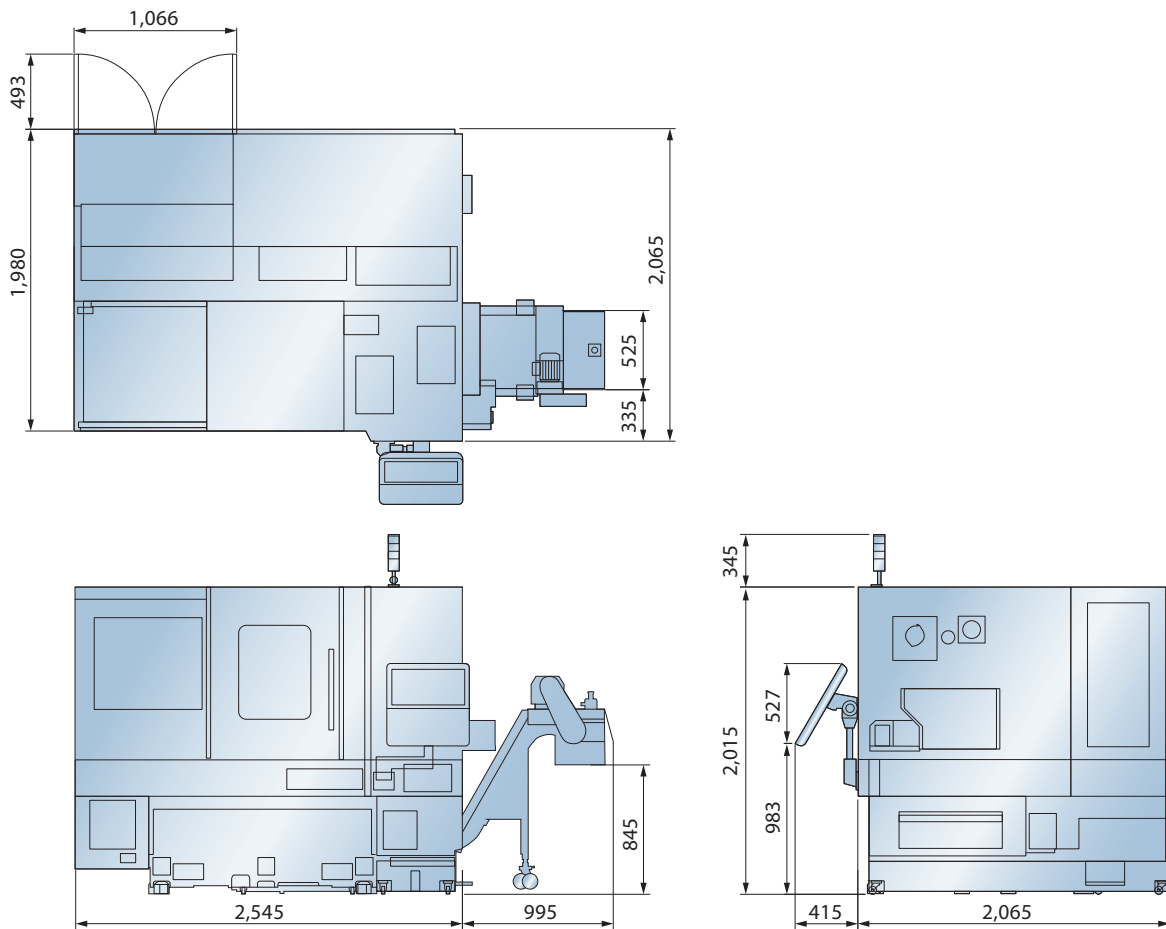

Unit : mm



GOODWAYCNC.com

GOODWAY MACHINE CORP.

HEADQUARTERS

No.13, 5th Road,
Taichung Industrial Park,
Taichung City, 407, Taiwan
E-mail : goodway@goodwaycnc.com

CENTRAL TAIWAN SCIENCE PARK BRANCH

No. 38, Keyuan Road,
Central Taiwan Science Park.Taichung,
Taichung City, 407, Taiwan
TEL : + 886-4-2463-6000
FAX : + 886-4-2463-9600

GOODWAY MACHINE (WUJIANG) CO.,LTD

No. 4888, East Lake Taihu Avenue, Wujiang
Economic and Technological Development Zone,
Jiangsu, China
Sales Hotline : + 86-512-8286-8068
Service Hotline : + 86-512-8286-8066
FAX : + 86-512-8286-8620
E-mail : goodway@goodwaycnc.cn